

This manual is for use
with catalog numbers
101ST462-UL-XX * and
29B020128-PPE.

* XX = number of modules



POWER⁺

MODULAR UPS SYSTEM

RM100 MODEL, 3X208 VAC, 10 kVA TO 100 kVA

User Guide



Release 2.7ys, August 2011

Har Hotzvim Industrial Park,
14 Hartom St., PO Box 45029, Jerusalem 91450, Israel
Tel: +972-2-588-8222 Fax: +972-2-582-8875
Email: info@gamatronic.co.il Website: www.gamatronic.com

Gamatronic Electronic Industries Ltd.

Har Hotzvim Industrial Park
14 Hartom St., PO Box 45029, Jerusalem 91450 Israel
Tel: +972-2-588-8222 Fax: +972-2-582-8875
Email: info@gamatronic.co.il Website: www.gamatronic.com



The equipment described in this document is not intended to be used in connection with any application requiring fail-safe performance, unless the application design includes appropriate redundancy. This exclusion includes, but is not limited to, the direct operation of any life support system or any other system whose failure could lead to serious injury, death, environmental damage or mass destruction.

© Copyright 2011 by Gamatronic Electronic Industries Ltd. All rights reserved worldwide.

The information contained in this document is proprietary and is subject to all relevant copyright, patent and other laws protecting intellectual property, as well as any specific agreement protecting Gamatronic Electronic Industries Ltd. rights in the aforesaid information. Neither this document nor the information contained herein may be published, reproduced or disclosed to third parties, in whole or in part, without the express, prior, written permission of Gamatronic Electronic Industries Ltd. In addition, any use of this document or the information contained herein for any purposes other than those for which it was disclosed is strictly forbidden.

Gamatronic Electronic Industries Ltd. reserves the right, without prior notice or liability, to make changes in equipment design or specifications.

Information supplied by Gamatronic Electronic Industries Ltd. is believed to be accurate and reliable. However, no responsibility is assumed by Gamatronic Electronic Industries Ltd. for the use thereof nor for the rights of third parties which may be affected in any way by the use thereof.

Any representation(s) in this document concerning performance of Gamatronic Electronic Industries Ltd. product(s) are for informational purposes only and are not warranties of future performance, either express or implied. Gamatronic Electronic Industries Ltd. standard limited warranty, stated in its sales contract or order confirmation form, is the only warranty offered by Gamatronic Electronic Industries Ltd. in relation thereto.

This document may contain flaws, omissions or typesetting errors; no warranty is granted nor liability assumed in relation thereto unless specifically undertaken in Gamatronic Electronic Industries Ltd. sales contract or order confirmation. Information contained herein is periodically updated and changes will be incorporated into subsequent editions. If you have encountered an error, please notify Gamatronic Electronic Industries Ltd. All specifications are subject to change without prior notice.

If the UPS is delivered without batteries, Gamatronic is not responsible for any damage or malfunction due to incorrect wiring of the batteries.

IN THE EVENT THAT SYSTEM OUTPUT CAPACITY IS INCREASED ABOVE THE ORIGINAL FACTORY CONFIGURATION, THE SYSTEM NAMEPLATE MUST BE UPDATED TO INDICATE THE NEW POWER AND CURRENT CAPACITY. This condition applies when new, non-redundant power modules are added to the system or when formerly redundant modules are designated as non-redundant.



SI LA CAPACITÉ DE SORTIE EST AUGMENTÉE AU DELÀ DE LA CONFIGURATION D'ORIGINE, LA PLAQUE INDICATIVE DU PRODUIT DOIT ÊTRE MISE A JOUR AVEC LES NOUVELLES CAPACITÉS.

Cette condition s'applique si de nouvelles modules onduleurs non redondantes sont ajoutées ou si des modules onduleurs redondantes sont désignées comme non redondantes.

STANDARDS AND CONVENTIONS

This manual contains diagrams that include images of the LCD display screen of the UPS. Unless otherwise indicated, the readings shown in the screen images are representational only, and are not intended to match the readings on a specific system in a particular environment.

TABLE OF CONTENTS

IMPORTANT SAFETY INSTRUCTIONS	XIV
Do's.....	xiv
Don'ts	xv
1. INTRODUCTION.....	1
1.1 <i>POWER+</i> has many unique features:.....	1
1.2 Ac and dc fuses	3
1.3 Ac input/output main terminals	3
1.4 System controller	3
1.5 UPS module (10 kVA / 8 kW)	3
1.6 Static Switch (ST/SW) module.....	3
2. BATTERY	4
2.1 Dc wiring	5
2.2 Battery replacement instructions	10
3. OPERATING MODES	11
3.1 Normal operation	11
3.2 Battery operation.....	11
3.3 Bypass operation	11
3.4 Maintenance bypass mode.....	12
4. USER INTERFACE	13
4.1 Control Panel	13
4.2 UPS Module Panel.....	13
4.3 Static Switch Panel	14
4.4 <i>POWER+</i> control screen.....	15
4.4.1 Load-level bar graph.....	15
4.5 Navigation and Operation Keypad.....	16
4.6 Status Indicators	17
4.7 Operation Buttons	18
4.8 Network Access Indicator	18
4.9 <i>POWER+</i> Operation Modes.....	19
4.9.1 Normal Operation	19
4.9.2 Battery Operation	19
4.9.3 Bypass Operation (Automatic)	20
4.9.4 Bypass Operation (Manual).....	20
4.9.5 Emergency Power off – EPO (Manual)	21
5. SYSTEM INSTALLATION	22
5.1 Cabling.....	22
5.2 The Power+ always requires a neutral line.....	26
5.2.1 A 4-pole switch might disconnect the neutral line	26
5.3 Ground connections.....	30
5.4 Over-Current Protection.....	33
5.4.1 Ac wiring	33
5.4.2 Dc wiring.....	34
5.5 Fuses	35
AC INPUT FUSES	35
DC DISTRIBUTION FUSES	36
5.6 Special terminal connections	37
5.6.1 Load on bypass alarm	37
5.6.2 Battery trip coil.....	37
5.6.3 Emergency power-off	38
5.7 Dry Contacts	39
5.8 Inspections to be performed prior to installation.....	40
5.9 Installation Procedure	41
5.10 First-time Startup	42
5.11 Checks to be performed following initial startup	45
5.12 Connection diagram.....	46
5.13 Configuration.....	47
5.13.1 Check Configured Modules	47
5.13.2 Check Total Ampere-Hours.....	49

5.13.3	Set Date and Time and Serial Number	50
5.13.4	Define the IP Address of the Power+	50
5.14	Testing	52
5.14.1	Blackout Test.....	52
5.14.2	Cold Start.....	52
5.14.3	Test Under Load.....	52
5.14.4	Check IP Communication with Controller.....	53
5.14.5	Test Wing Option.....	55
6.	POWER+ ROUTINE START-UP	57
6.1	Start-up after Shutdown	57
6.2	POWER+ Shutdown (Switching to Bypass)	59
6.3	POWER+ Total Shutdown (No Ac Output)	59
7.	POWER+ CONTROL PANEL.....	61
7.1	Quick-reference summary of Power+ menu functions	62
8.	POWER+ MENU FUNCTIONS IN DETAIL.....	67
8.1	Main Menu	67
8.2	“System” Option	68
8.3	“UPS module” Option.....	72
8.4	“Self-test” Option.....	74
8.5	“History” (logs) Option.....	75
8.6	“Battery” Option.....	79
8.7	“Alarm” Option.....	82
8.8	“Setup – Alarm Set” Option.....	84
8.8.1	Setting Ac Voltage Alarms.....	85
8.8.2	Setting Battery Floating Voltage Alarm	86
8.8.3	Setting Battery Over/Under Temperature Alarms	88
8.8.4	Setting Battery Integration Alarm	89
8.9	“Setup – Module Conf.” Option	91
8.9.1	Setting Number of Phases	92
8.9.2	Setting Module/s Frequency.....	92
8.9.3	Setting Module/s Voltage.....	93
8.9.4	Update Voltage/Frequency/Phase	93
8.9.5	Output Adjustment.....	94
8.9.6	Setting Frequency Limits	95
8.9.7	Calibrating DC Voltage.....	95
8.9.8	Calibrating AC Voltage	96
8.10	“Setup – Battery” Option	97
8.10.1	Setting Battery Test Voltage.....	98
8.10.2	Setting Battery Test Voltage Alarm	99
8.10.3	Setting Battery Current Limit	100
8.10.4	Enable/Disable Battery Current Limit	101
8.10.5	Setting Temperature Compensation	102
8.10.6	Setting Disable Temperature Compensation	103
8.10.7	Setting Absolute Maximum and Minimum Voltages.....	103
8.10.8	Activating the Battery Test.....	105
8.10.9	Setting the Automatic Battery Test Period	105
8.10.10	Setting the Automatic Battery Test Top Time	106
8.10.11	Setting the N th Battery Capacity	107
8.10.12	Activating ‘Auto’ Test.....	108
8.10.13	Enabling/Disabling Options	108
8.11	Setup – Charge, Time, Site, and Password Options	110
8.11.1	Setting the Floating Charge.....	111
8.11.2	Setting the Time	112
8.11.3	Setting the Site Number	112
8.11.4	Changing the Password	113
8.12	“Setup – “Service” Option	114
8.12.1	Setting UPSs	116
8.12.2	Testing Dry Output Relays	116
8.12.3	Configuring the UPS.....	117
8.12.3.1	Number of Redundant UPSs.....	117
8.12.3.2	Total Number of UPSs	118

8.12.3.3	Total Number of Batteries.....	118
8.12.3.4	Setting up the Static Switch.....	119
8.12.3.5	Setting up the Dry Alarms.....	120
8.12.3.6	Calibrating DC Currents.....	121
8.12.3.7	Selecting Standalone or Parallel Operation.....	122
8.12.3.8	Enabling/Disabling Remote Commands.....	123
8.12.4	Enabling/Disabling Current Sharing.....	123
8.12.5	Setting Power Factor Correction.....	124
8.12.6	Setting the SC2012.....	124
8.13	“Setup – “Silicon” Option.....	128
8.14	“Static Switch” option.....	131
8.15	System Controller Setup Verification.....	132
8.15.1	Setup Verification Menu.....	132
8.15.2	Connection Status of UPSs.....	133
8.15.3	On/Off Status of UPSs.....	133
8.15.4	Software and Communication Revision.....	133
8.15.5	Network Parameters.....	134
8.15.6	Dry Input and Output Relay Contact Status.....	134
8.15.7	Alarms Status.....	134
8.15.8	Setting the Menu Language.....	135
8.15.9	System Parameter Settings.....	135
8.15.9.1	First General Screen.....	135
8.15.9.2	Second General Screen.....	136
8.15.9.3	Third General Screen.....	137
8.15.9.4	Fourth General Screen.....	137
9.	THE POWER+ BUILT-IN WEB INTERFACE.....	138
9.1	Preliminaries to use of the Web interface.....	138
9.2	Main Screen.....	139
9.3	The Main Menu and its options.....	140
9.3.1	“Analysis” main menu option.....	141
9.3.2	“Modules” main menu option.....	141
9.3.3	“STSW” (Static Switch) main menu option.....	142
9.3.4	“Log” main menu option.....	143
9.3.5	“Control” main menu option.....	145
9.3.6	“SMS” main menu option.....	146
9.3.7	“Configuration” main menu option.....	147
9.3.7.1	Network configuration.....	148
9.3.7.2	“Date and time” – setting the calendar and clock.....	148
9.3.7.3	Set user name and password.....	149
9.3.7.4	SNMP security.....	150
9.3.7.5	SNMP trap targets.....	150
9.3.7.6	Shutdown Targets.....	151
9.3.7.7	Defining email notification targets.....	153
9.3.7.8	Defining SMS notifications.....	154
10.	SNMP AGENT.....	155
11.	WING: WIRELESS CONTROL (OPTION).....	156
11.1	Installing the Wing.....	156
12.	RELATED PRODUCTS.....	160
12.1	G4.....	160
12.2	G-Eye.....	161
13.	MAINTENANCE BYPASS MODE.....	162
13.1	Putting the UPS in maintenance bypass mode.....	162
13.2	Returning the UPS to normal operation.....	163
14.	PREVENTIVE MAINTENANCE.....	164
15.	SERVICE AND REPAIRS.....	164
16.	TECHNICAL SPECIFICATIONS.....	165

LIST OF FIGURES

FIGURE 1: MAIN SUBASSEMBLIES OF THE RM100	2
FIGURE 2: BATTERY CABINET	6
FIGURE 3: ONE BATTERY BOX	7
FIGURE 4: ONE BATTERY DRAWER	7
FIGURE 5: BATTERY CABINET WIRING	8
FIGURE 6: CONTROL PANEL	13
FIGURE 7: UPS MODULE PANEL	13
FIGURE 8: STATIC SWITCH PANEL.....	14
FIGURE 9: POWER+ CONTROL SCREEN	15
FIGURE 10: NAVIGATION AND OPERATION KEYPAD	16
FIGURE 11: STATUS INDICATORS	17
FIGURE 12: NETWORK ACCESS INDICATOR	18
FIGURE 13: POWER+ CONTROL SCREEN IN NORMAL OPERATION.....	19
FIGURE 14: NORMAL OPERATION INDICATION.....	19
FIGURE 15: AC POWER FAILURE	19
FIGURE 16: AC POWER FAILURE INDICATION.....	20
FIGURE 17: UPS IN BYPASS MODE	20
FIGURE 18: RED ALARM FLASHING	20
FIGURE 19: RM100 3x208 V, REAR VIEW	23
FIGURE 20: CABLE ENTRY FROM THE TOP OR BOTTOM OF UPS CABINET	24
FIGURE 21: CONNECTION DIAGRAM FOR 3-3 CONFIGURATION.....	25
FIGURE 22: WRONG WAY TO CONNECT UPS WITH FOUR-POLE SWITCH.....	27
FIGURE 23: ACCEPTABLE CONNECTION FOR GROUNDED GENERATOR AND 4-POLE SWITCH.....	28
FIGURE 24: PREFERRED GENERATOR (NEUTRALIZED) AND CONNECTION (3-POLE).....	29
FIGURE 25: GROUND CONNECTIONS ON THE UPS CABINET ROOF.....	30
FIGURE 26: CRIMP -TYPE CABLE SHOES RECOMMENDED FOR ALL GROUND CABLES	31
FIGURE 27: GROUND STUDS ON UPS CABINET ROOF, VIEW FROM BELOW	31
FIGURE 28: GROUND STUDS ON INSIDE OF BATT. CABINET ROOF	32
FIGURE 29: GROUND BUS BAR AT BASE OF UPS REAR	32
FIGURE 30: AC INPUT FUSES (100 kVA MODEL).....	35
FIGURE 31: DC DISTRIBUTION FUSE ASSIGNMENT (100 kVA).....	36
FIGURE 32: SPECIAL PURPOSE TERMINAL CONNECTIONS.....	37
FIGURE 33: DRY CONTACTS ON REAR OF CONTROLLER	39
FIGURE 34: START-UP SCREEN 1	42
FIGURE 35: START-UP SCREEN 2	42
FIGURE 36: START-UP SCREEN 3	42
FIGURE 37: START-UP SCREEN 4	43
FIGURE 38: DEFAULT SCREEN, WITH NO LOAD, FOR 3-PHASE OUTPUT	43
FIGURE 39: DEFAULT SCREEN, WITH NO LOAD, FOR 2-PHASE OUTPUT	43
FIGURE 40: NORMAL DISPLAY, SYSTEM UNDER LOAD (3-PHASE OUTPUT).....	44
FIGURE 41: NORMAL DISPLAY, SYSTEM UNDER LOAD (2-PHASE OUTPUT).....	44
FIGURE 42: CONNECTION DIAGRAM (FOR COMPLETION BY THE CUSTOMER).....	46
FIGURE 43: MAIN MENU	47
FIGURE 44: PASSWORD ACCESS	47
FIGURE 45: SETUP MENU	47
FIGURE 46: SERVICE MENU	48
FIGURE 47: CONFIGURE MENU.....	48
FIGURE 48: # OF UPSs (TOTAL).....	48
FIGURE 49: # OF UPSs (REDUNDANCY).....	48
FIGURE 50: BATTERY STATUS.....	49

FIGURE 51: BATTERY CAPACITY	49
FIGURE 52: SET BATTERY CAPACITY	49
FIGURE 53: DATE AND TIME	50
FIGURE 54: SITE NUMBER.....	50
FIGURE 55: NETWORK MENU	50
FIGURE 56: IP ADDRESS	51
FIGURE 57: GATEWAY	51
FIGURE 58: NETWORK MENU	51
FIGURE 59: NETWORK CONNECTIONS SCREEN	53
FIGURE 60: LOCAL AREA CONNECTION PROPERTIES SCREEN	54
FIGURE 61: INTERNET PROTOCOL (TCP/IP) PROPERTIES SCREEN	54
FIGURE 62: MAIN SCREEN OF BUILT-IN WEB SERVER.....	55
FIGURE 63: LOGIN SCREEN OF BUILT-IN WEB SERVER.....	56
FIGURE 64: SMS SCREEN	56
FIGURE 65: MAIN SCREEN AFTER A POWER SHUTDOWN.....	57
FIGURE 66: MAIN SCREEN AFTER A POWER SHUTDOWN INDICATION	57
FIGURE 67: MAIN SCREEN AT POWER-UP.....	57
FIGURE 68: NORMAL OPERATION INDICATION.....	58
FIGURE 69: MAIN SCREEN RESULTS	58
FIGURE 70: MAIN SCREEN – SWITCHING TO BYPASS.....	59
FIGURE 71: BYPASS INDICATION	59
FIGURE 72: MAIN SCREEN – TOTAL SHUTDOWN	59
FIGURE 73: UPS OFF INDICATION	60
FIGURE 74: CONTROL PANEL	61
FIGURE 75: MAIN MENU.....	62
FIGURE 76: SYSTEM MENU	62
FIGURE 77: BATTERY MENU.....	63
FIGURE 78: SETUP MENU	63
FIGURE 79: STATIC SWITCH MENU.....	63
FIGURE 80: ALARM SET SUB-MENU.....	64
FIGURE 81: MODULE CONFIGURATION SUB-MENU	64
FIGURE 82: BATTERY MENU.....	64
FIGURE 83: SERVICE SUB-MENU	65
FIGURE 84: CONFIGURE SUB-SUB-MENU	66
FIGURE 85: SILICON SUB-MENU	66
FIGURE 86: MAIN MENU.....	67
FIGURE 87: MAIN MENU OPTION 1 ("SYSTEM").....	68
FIGURE 88: SYSTEM DC VOLTAGES	68
FIGURE 89: OUTPUT POWER FACTOR 1	69
FIGURE 90: INPUT POWER FACTOR 1.....	69
FIGURE 91: OVERALL PHASE VOLTAGES/CURRENTS	69
FIGURE 92: ELAPSED TIME	69
FIGURE 93: JUMPER SETTINGS WITHOUT REMOTE PANEL	70
FIGURE 94: JUMPER SETTINGS WITH REMOTE PANEL.....	70
FIGURE 95: INTERNAL CONTROLLER VOLTAGES.....	70
FIGURE 96: BATTERY PARAMETERS	70
FIGURE 97: FUSE STATUS.....	71
FIGURE 98: COMMUNICATION WITH INVERTER – TRANSMIT	71
FIGURE 99: COMMUNICATION WITH INVERTER – RECEIVE	71
FIGURE 100: MAIN MENU OPTION 2 ("UPS MODULE").....	72
FIGURE 101: LCD PANEL – SELECT A UPS	72
FIGURE 102: MODULE PHASE VOLTAGES/CURRENTS.....	73

FIGURE 103: BATTERY VOLTAGES & TECHNICIAN PARAMETERS	73
FIGURE 104: MAIN MENU OPTION 3 (“SELF TEST”)	74
FIGURE 105: RESULT SCREEN FROM SELF-TEST	74
FIGURE 106: MAIN MENU OPTION 4 (“HISTORY”)	75
FIGURE 107: HISTORY LOGS.....	75
FIGURE 108: HISTORY LOG SCROLL	76
FIGURE 109: MAIN MENU OPTION 5 (“BATTERY”).....	79
FIGURE 110: BATTERY STATUS.....	79
FIGURE 111: BATTERY EQUALIZING.....	80
FIGURE 112: TIME LEFT.....	80
FIGURE 113: LAST TEST	80
FIGURE 114: BATTERY CURRENT	80
FIGURE 115: BATTERY CAPACITY	81
FIGURE 116: BATTERY CURRENT LIMIT	81
FIGURE 117: MAIN MENU OPTION 6 (“ALARM”)	82
FIGURE 118: ALARMS 01-12	82
FIGURE 119: ALARMS 13-24	83
FIGURE 120: ALARMS 25-32	83
FIGURE 121: MAIN MENU OPTION 7 (“SETUP – ALARM SET”).....	84
FIGURE 122: LEVEL 1 PASSWORD ACCESS	84
FIGURE 123: SETUP MENU	85
FIGURE 124: ALARM SETUP MENU.....	85
FIGURE 125: AC ALARMS MENU	85
FIGURE 126: SET AC ALARM VOLTAGE LEVELS	85
FIGURE 127: AC ALARMS MENU	86
FIGURE 128: SET AC VOLTAGE HYSTERESIS	86
FIGURE 129: ALARM SET MENU.....	86
FIGURE 130: BATTERY FLOATING CHARGE ALARM SETUP MENU	86
FIGURE 131: SET BATEND	87
FIGURE 132: BATTERY FLOATING CHARGE ALARM SETUP MENU	87
FIGURE 133: SET BATLOW.....	87
FIGURE 134: BATTERY FLOATING CHARGE ALARM SETUP MENU	87
FIGURE 135: SET BAT-HI.....	88
FIGURE 136: ALARM SET MENU.....	88
FIGURE 137: OVER/UNDER TEMPERATURE MENU	88
FIGURE 138: SET BATTERY MAXIMUM TEMPERATURE ALARM	88
FIGURE 139: OVER/UNDER TEMPERATURE MENU	89
FIGURE 140: SET BATTERY MINIMUM TEMPERATURE ALARM	89
FIGURE 141: ALARM SET MENU.....	89
FIGURE 142: SET THE INTEGRATION FACTOR ALARM	90
FIGURE 143: MAIN MENU OPTION 7 (“SETUP – MODULE CONF.”).....	91
FIGURE 144: LEVEL 1 PASSWORD ACCESS	91
FIGURE 145: SETUP MENU	92
FIGURE 146: MODULE CONFIG. SETUP MENU.....	92
FIGURE 147: MODULE CONFIG. SETUP MENU.....	92
FIGURE 148: SETTING THE MODULE/S FREQUENCY.....	92
FIGURE 149: MODULE CONFIG. SETUP MENU.....	93
FIGURE 150: SETTING THE MODULE/S VOLTAGE	93
FIGURE 151: MODULE CONFIG. SETUP MENU.....	93
FIGURE 152: UPDATING THE MODULE/S VOLTAGE/FREQUENCY/PHASE.....	93
FIGURE 153: MODULE CONFIG. SETUP MENU.....	94
FIGURE 154: SELECT A PHASE TO ADJUST	94

FIGURE 155: SELECT A MODULE TO ADJUST	94
FIGURE 156: SELECT A VALUE TO ADJUST	94
FIGURE 157: MODULE CONFIG. SETUP MENU.....	95
FIGURE 158: SELECT THE FREQUENCY LIMITS.....	95
FIGURE 159: MODULE CONFIG. SETUP MENU.....	95
FIGURE 160: CALIBRATE POSITIVE OR NEGATIVE VOLTAGE.....	95
FIGURE 161: ENTER MEASURED VALUE	96
FIGURE 162: MODULE CONFIG. SETUP MENU.....	96
FIGURE 163: CALIBRATE INPUT OR OUTPUT VOLTAGE.....	96
FIGURE 164: ENTER MEASURED VALUE	96
FIGURE 165: MAIN MENU OPTION 7 (“SETUP – BATTERY”)	97
FIGURE 166: LEVEL 1 PASSWORD ACCESS	98
FIGURE 167: SETUP MENU	98
FIGURE 168: BATTERY SETUP MENU	98
FIGURE 169: SET BATTERY TEST VOLTAGE	98
FIGURE 170: BATTERY SETUP MENU	99
FIGURE 171: SET BATTERY TEST VOLTAGE ALARM	99
FIGURE 172: BATTERY SETUP MENU	100
FIGURE 173: CURRENT LIMIT SETUP MENU.....	100
FIGURE 174: CURRENT LIMIT INDICATION FOR (EACH) BATTERY	100
FIGURE 175: SET CURRENT LIMIT FOR (EACH) BATTERY.....	100
FIGURE 176: BATTERY SETUP MENU	101
FIGURE 177: CURRENT LIMIT SETUP MENU.....	101
FIGURE 178: ENABLE/DISABLE CURRENT LIMIT	101
FIGURE 179: BATTERY SETUP MENU	102
FIGURE 180: TEMPERATURE COMPENSATION SETUP MENU.....	102
FIGURE 181: SET TEMPERATURE COMPENSATION.....	102
FIGURE 182: BATTERY SETUP MENU	103
FIGURE 183: ENABLE/DISABLE TEMPERATURE COMPENSATION	103
FIGURE 184: SELECT SET ABSOLUTE MAX & MIN VOLTAGES.....	103
FIGURE 185: SELECT SET ABSOLUTE MINIMUM OUTPUT VOLTAGE	104
FIGURE 186: SET ABSOLUTE MINIMUM OUTPUT VOLTAGE WHEN COMPENSATING.....	104
FIGURE 187: SELECT SET ABSOLUTE MAXIMUM OUTPUT VOLTAGE	104
FIGURE 188: SET ABSOLUTE MAXIMUM OUTPUT VOLTAGE WHEN COMPENSATING.....	104
FIGURE 189: BATTERY SETUP MENU	105
FIGURE 190: SELECT ACTIVATE BATTERY TEST.....	105
FIGURE 191: ACTIVATE BATTERY TEST	105
FIGURE 192: BATTERY SETUP MENU	105
FIGURE 193: SELECT SET AUTO BATTERY TEST PERIOD	106
FIGURE 194: SET BATTERY TEST PERIOD.....	106
FIGURE 195: BATTERY SETUP MENU	106
FIGURE 196: SELECT SET AUTO BATTERY TEST TOP TIME.....	106
FIGURE 197: SET BATTERY TEST TOP TIME	107
FIGURE 198: BATTERY SETUP MENU	107
FIGURE 199: SELECT SET CAPACITY OF BATTERY #1	107
FIGURE 200: SET BATTERY CAPACITY	107
FIGURE 201: BATTERY SETUP MENU	108
FIGURE 202: ACTIVATED ‘AUTO’ TEST	108
FIGURE 203: BATTERY SETUP MENU	108
FIGURE 204: ENABLE/DISABLE SHUTDOWN BY LONG AC FAILURE	109
FIGURE 205: MAIN MENU OPTION 7 (“SETUP – CHARGE, TIME, SITE, & PASSWORD”).....	110
FIGURE 206: LEVEL 1 PASSWORD ACCESS	110

FIGURE 207: SETUP MENU	111
FIGURE 208: CHARGE SETUP MENU	111
FIGURE 209: SET FLOATING CHARGE	111
FIGURE 210: SETUP MENU	112
FIGURE 211: SET DATE AND TIME.....	112
FIGURE 212: SETUP MENU	112
FIGURE 213: SET SITE NUMBER	112
FIGURE 214: SETUP MENU	113
FIGURE 215: CHANGE PASSWORD	113
FIGURE 216: MAIN MENU OPTION 7 (“SETUP – SERVICE”) 1/2	114
FIGURE 217: MAIN MENU OPTION 7 (“SETUP – SERVICE”) 2/2	115
FIGURE 218: LEVEL 1 PASSWORD ACCESS	115
FIGURE 219: SETUP MENU	116
FIGURE 220: SERVICE MENU	116
FIGURE 221: SET UPSs.....	116
FIGURE 222: SERVICE MENU	116
FIGURE 223: SET UPSs.....	117
FIGURE 224: SERVICE MENU	117
FIGURE 225: SERVICE > CONFIGURE MENU.....	117
FIGURE 226: SET NUMBER OF REDUNDANT UPSs.....	117
FIGURE 227: SERVICE > CONFIGURE MENU.....	118
FIGURE 228: SET TOTAL NUMBER OF UPSs	118
FIGURE 229: SERVICE > CONFIGURE MENU.....	118
FIGURE 230: SET TOTAL NUMBER OF BATTERIES.....	118
FIGURE 231: SERVICE > CONFIGURE MENU.....	119
FIGURE 232: STATIC SWITCH SETUP MENU.....	119
FIGURE 233: SET THE MASK	119
FIGURE 234: STATIC SWITCH SETUP MENU.....	119
FIGURE 235: SERVICE > CONFIGURE MENU.....	120
FIGURE 236: DRY RELAY MENU.....	120
FIGURE 237: SET DRY CONTACT N ALARM ASSOCIATIONS	120
FIGURE 238: ENABLE / DISABLE ALARMS	120
FIGURE 239: SERVICE > CONFIGURE MENU.....	121
FIGURE 240: DC-I MENU	121
FIGURE 241: REMOVE CURRENT OFFSETS.....	121
FIGURE 242: DC-I MENU	121
FIGURE 243: CALIBRATING DC CURRENT	122
FIGURE 244: ENTERING ACTUAL CURRENT	122
FIGURE 245: SERVICE > CONFIGURE MENU.....	122
FIGURE 246: SETTING STANDALONE OR PARALLEL OPERATION	122
FIGURE 247: SERVICE > CONFIGURE MENU.....	123
FIGURE 248: ENABLING/DISABLING REMOTE COMMANDS	123
FIGURE 249: SERVICE MENU	123
FIGURE 250: ENABLING/DISABLING CURRENT SHARING	123
FIGURE 251: SERVICE MENU	124
FIGURE 252: ENABLING/DISABLING POWER FACTOR CORRECTION.....	124
FIGURE 253: SERVICE MENU	124
FIGURE 254: SC2012 MENU	124
FIGURE 255: SC2012 MENU	125
FIGURE 256: SC2012 MENU	125
FIGURE 257: NETWORK MENU	125
FIGURE 258: SETTING AN IP ADDRESS	125

FIGURE 259: NETWORK MENU	126
FIGURE 260: SETTING THE GATEWAY	126
FIGURE 261: NETWORK MENU	126
FIGURE 262: SETTING THE MASK	126
FIGURE 263: NETWORK MENU	127
FIGURE 264: NETWORK MENU	127
FIGURE 265 : SETTING THE SNMP NO COMM FACTOR.....	127
FIGURE 266: SC2012 MENU	127
FIGURE 267 :MAIN MENU OPTION 7 (“SETUP – STATIC SWITCH”).....	128
FIGURE 268: LEVEL 1 PASSWORD ACCESS	128
FIGURE 269: SETUP MENU	128
FIGURE 270: SILICON MENU.....	129
FIGURE 271: SILICON MENU.....	129
FIGURE 272: SILICON DEFAULTS	129
FIGURE 273: CONFIRMATION SCREEN	129
FIGURE 274: SILICON MENU.....	130
FIGURE 275: STATIC SWITCH OPTION	131
FIGURE 276: STATIC SWITCH VOLTAGE AND FREQUENCY.....	131
FIGURE 277: STATIC SWITCH MESSAGING STATUS	131
FIGURE 278: SETUP VERIFICATION SCREENS	132
FIGURE 279: SETUP VERIFICATION MENU	132
FIGURE 280: CONNECTION STATUS OF UPSs.....	133
FIGURE 281: ON/OFF STATUS OF UPSs	133
FIGURE 282: SOFTWARE AND COMMUNICATION REVISION.....	133
FIGURE 283: NETWORK PARAMETERS.....	134
FIGURE 284: DRY INPUT AND OUTPUT RELAY CONTACT STATUS	134
FIGURE 285: ALARMS STATUS	134
FIGURE 286: SET MENU LANGUAGE.....	135
FIGURE 287: SELECT GENERAL	135
FIGURE 288: GENERAL (SCREEN 1)	135
FIGURE 289: GENERAL (SCREEN 2).....	136
FIGURE 290: GENERAL (SCREEN 3).....	137
FIGURE 291: GENERAL (SCREEN 4).....	137
FIGURE 292: POWER+ CONTROLLER REAR PANEL.....	138
FIGURE 293: MAIN SCREEN OF THE POWER+ WEB INTERFACE.....	139
FIGURE 294: ANALYSIS OF SYSTEM INPUT AND OUTPUT VOLTAGES AND POWER.....	141
FIGURE 295: MODULES MEASUREMENTS AND STATUS DISPLAY.....	141
FIGURE 296: STATIC SWITCH DATA AND STATUS DISPLAY.....	142
FIGURE 297: LISTING THE LOG ENTRIES	143
FIGURE 298: THE "CONTROL" MAIN MENU OPTION SCREEN.....	145
FIGURE 299: “SMS” SCREEN.....	146
FIGURE 300: CONFIGURATION MENU.....	147
FIGURE 301: CONFIGURING NETWORK COMMUNICATION PARAMETERS.....	148
FIGURE 302: SETTING THE POWER+ INTERNAL DATE AND TIME	148
FIGURE 303: CHANGING USERNAME AND PASSWORD OF THE WEB INTERFACE	149
FIGURE 304: DEFINE SNMP PERMISSIONS.....	150
FIGURE 305: DEFINING SNMP TRAP TARGETS	150
FIGURE 306: DEFINE COMPUTERS FOR AUTO-SHUTDOWN.....	151
FIGURE 307: DEFINING EMAIL NOTIFICATION TARGETS	153
FIGURE 308: DEFINING SMS RECIPIENTS.....	154
FIGURE 309: POWER+ PSM-AC LETS YOU MONITOR AND CONTROL YOUR POWER+ UPS	155
FIGURE 310: A WING UNIT CONNECTED TO THE POWERPLUS.....	156

FIGURE 311: CONNECTIONS BETWEEN THE POWER+ CONTROLLER AND THE WING..... 157
 FIGURE 312: HOME SCREEN OF THE POWER+ WEB INTERFACE 157
 FIGURE 313: THE SMS SCREEN ON THE POWER+ WEB INTERFACE 158
 FIGURE 314: GMACi G4..... 160
 FIGURE 315: G-EYE..... 161

LIST OF TABLES

TABLE 1: BATTERY LIFETIME VS ENVIRONMENTAL TEMPERATURE9
 TABLE 2: STATUS INDICATORS17
 TABLE 3: OPERATION BUTTONS18
 TABLE 4: NETWORK ACCESS INDICATION18
 TABLE 5: KEY TO FIGURE 27.....31
 TABLE 6: KEY TO FIGURE 28 AND FIGURE 29 ABOVE32
 TABLE 7: REQUIRED OVER-CURRENT PROTECTION.....33
 TABLE 8: PRE-INSTALLATION INSPECTIONS40
 TABLE 9: INSTALLATION PROCEDURE41
 TABLE 10: CHECKS AFTER INITIAL STARTUP.....45
 TABLE 11: MAIN MENU OPTIONS.....67
 TABLE 12: LOG MESSAGES.....77
 TABLE 13: INTERPRETING THE STATIC SWITCH TRANSFER CODE (LOADBP).....78
 TABLE 14: MAIN SCREEN FEATURES 139
 TABLE 15: MAIN MENU OPTIONS 140
 TABLE 16: DATA ITEMS ON THE EVENT LOG SCREEN 143
 TABLE 17: ALARM MESSAGE TEXT IN WEB INTERFACE LOG DISPLAY 144
 TABLE 18: COMMANDS AVAILABLE ON THE “CONTROL” SCREEN 145
 TABLE 19: DEFINING COMPUTERS FOR AUTO-SHUTDOWN 151
 TABLE 20: FIELDS IN THE EMAIL NOTIFICATIONS SCREEN 153
 TABLE 21: FIELDS IN THE SMS NOTIFICATION TARGET DEFINITION SCREEN 154
 TABLE 22: LIST OF SMS COMMANDS..... 159
 TABLE 23: NORMAL OPERATING POSITION OF THE AC CIRCUIT BREAKERS 162
 TABLE 24: POSITION OF THE AC CBS IN MAINT. BYPASS MODE 162
 TABLE 25: TECHNICAL SPECIFICATIONS FOR THE RM100 3x208 VAC..... 165

R E C Y C L I N G I N F O R M A T I O N

Consult your local recycling or hazardous waste center for information on proper disposal of a used battery or UPS.

WARNING



Do not dispose of batteries in a fire. Batteries may explode. Consult with your local recycling / hazardous waste center for disposal requirements.

CAUTION



Do not discard the UPS or its batteries in the trash. This product contains sealed lead-acid batteries. For proper disposal, contact your local recycling / hazardous waste center.

CAUTION



Do not discard waste electrical or electronic equipment (WEEE) in the trash. For proper disposal, contact your local recycling / hazardous waste center.

IMPORTANT SAFETY INSTRUCTIONS (SAVE THESE INSTRUCTIONS)

This manual contains important instructions for the **Power+ RM100 3x208 Vac** model.

The **POWER+** UPS system is designed for industrial applications and harsh environments. Nevertheless, the **POWER+** UPS system is a sophisticated power system and should be handled with appropriate care, following these guidelines.

Do's

- Read this manual carefully before starting installation and operation of the UPS.
- Review the safety precautions described below to avoid injury to users or damaging equipment.
- This UPS is intended for installation in a temperature-controlled, indoor area that is free from conductive contaminants.
- All power connections must be completed by a licensed electrician who is experienced in wiring this type of equipment, and who is knowledgeable about all federal, state, and local electrical codes and regulations. **Improper wiring may cause damage to the equipment or injury to personnel.**
- Pay attention to the warning signs, labels and marks on the unit. A warning sign signals the presence of a possibly serious, life-threatening condition.
- Keep the surroundings clean, uncluttered and free from excess moisture.
- Allow only qualified technicians to service the UPS. There are no user-serviceable components. **Do not try to repair it yourself!**
- Use the UPS only for its intended purpose.
- The battery cabinet should be located as close to the UPS as is practically possible.



CAUTION - WARNING - RISK OF LETHAL ELECTRIC SHOCK:

The battery drawer contains a series of 12-Volt batteries that provide high voltage and energy in the UPS body even when the UPS is not connected to the ac input. Appropriate precautions should be taken during installation, inspection and servicing.



CAUTION - WARNING - RISK OF LETHAL ELECTRIC SHOCK:

The UPS receives power from more than one source. Disconnection of all of the ac sources and the dc source is required to de-energize this unit before servicing.



ATTENTION - AVERTISSEMENT - RISQUE DE DÉCHARGE ÉLECTRIQUE MORTELLE :

Le module de batterie contient une série de batteries 12-Volt qui fournissent une haute tension et l'énergie dans le corps de l'onduleur même lorsque l'onduleur n'est pas relié à l'entrée à A.C. Des précautions appropriées devraient être prises pendant l'installation, l'inspection et l'entretien.



ATTENTION - AVERTISSEMENT - RISQUE DE DÉCHARGE ÉLECTRIQUE MORTELLE :

L'onduleur reçoit la puissance de plus d'une source. Le débranchement de toutes les sources à **A.C.** et source de **D.C** est exigé pour désactiver cette unité avant l'entretien.

Don'ts

- Do not open the cover of the UPS or the battery cabinets under any circumstances. All UPS panels and doors should be closed.
- Do not insert any objects through the ventilation holes.
- Do not put objects on the UPS.
- Do not move the UPS while it is operating.
- Do not use the UPS outdoors.
- Do not turn the UPS upside down during transportation.
- Do not connect or disconnect the cable to the battery cabinet before the battery circuit breaker is turned OFF.
- Do not turn ON the battery circuit breaker when the battery cabinet is disconnected from the UPS.
- Do not install next to any gas or electrical heaters. A restricted location is recommended in order to prevent access by unauthorized personnel.



WARNING: RISK OF SEVERE DAMAGE TO THE UPS!!!

This system uses the neutral line for operation. Therefore, it is strictly forbidden to connect this system to the ac power source without a neutral (null) conductor!!

Failure to use a neutral conductor may cause permanent damage to the system.



AVERTISSEMENT : RISQUE DE DOMMAGES GRAVES À L'ONDULEUR !!!

Ce système emploie la ligne neutre pour l'opération. Par conséquent, il est strictement interdit de relier ce système à la source (ac) de courant alternative sans conducteur neutre (nul)!!

L'échec à l'utilisation d'un conducteur neutre peut endommager en le système de façon permanente.



CAUTION - GROUND CONNECTION ESSENTIAL BEFORE CONNECTING SUPPLY

Connect the UPS to ground before connecting it to the ac supply.



ATTENTION - LA PRISE DE TERRE AU SOL EST ESSENTIELLE AVANT DE RELIER L'APPROVISIONNEMENT

mettre l'onduleur à la terre avant de le relier à l'alimentation à A.C.



WARNING - RISK OF ELECTRIC SHOCK! DO NOT OPEN THE REAR DOOR!

Do not open the rear door of the UPS cabinet. Keep the rear door locked. The rear door should be opened only by an authorized technician.



**ATTENTION - RISQUE DE CHOC ÉLECTRIQUE!
NE PAS OUVRIR PORTE ARRIERE!**

Ne pas ouvrir la porte arrière de l'armoire de l'onduleur. Gardez la porte arrière verrouillée. Seul un technicien qualifié peut ouvrir la porte arrière de l'armoire de l'onduleur.

1. INTRODUCTION

In general, an Uninterruptible Power Supply (UPS) provides backup power for use when the utility ac electric power mains fail or drop to an unacceptable voltage level. **POWER+** is a whole lot more.

POWER+ is designed to protect your data and equipment and minimize downtime and other adverse effects normally incurred by power irregularities and failures.

POWER+ continually eliminates surges, spikes and sags that are inherent in commercial utility power. Over time, these irregularities shorten the life of equipment and components. The efficiency of **POWER+** thus helps to extend the life of your equipment, even through normal use when the input power system is constant and continuous.

POWER+ requires very little attention or intervention during normal operation; however, you should read and understand the procedures described in this manual to ensure trouble-free operation.

POWER+ is a parallel redundant UPS and is flexible in structure, allowing it to be easily extended by adding modules as required. The UPS modules are designed for hot swapping, making many different configurations possible.

The **POWER+ RM100** model fits into a standard 19" wide enclosure and is configurable for a capacity of 10 to 100 kVA.

1.1 **POWER+** has many unique features:

POWER+ is:

- Reliable, thanks to its N+ 1 parallel redundancy.
- Both flexible and modular; it may include from one to ten modules.
- A true on-line battery design according to IEC62040-3.
- A "green" power solution thanks to a THD of 5 % at the input, and provides "clean" power to your loads.
- A UPS that employs active current sharing at the input / output.
- A UPS that has an overall efficiency of up to 96 % and a backup efficiency of 98 %.
- Light and small, a 10 kVA module weighs approximately 22 lb. (10 Kg).

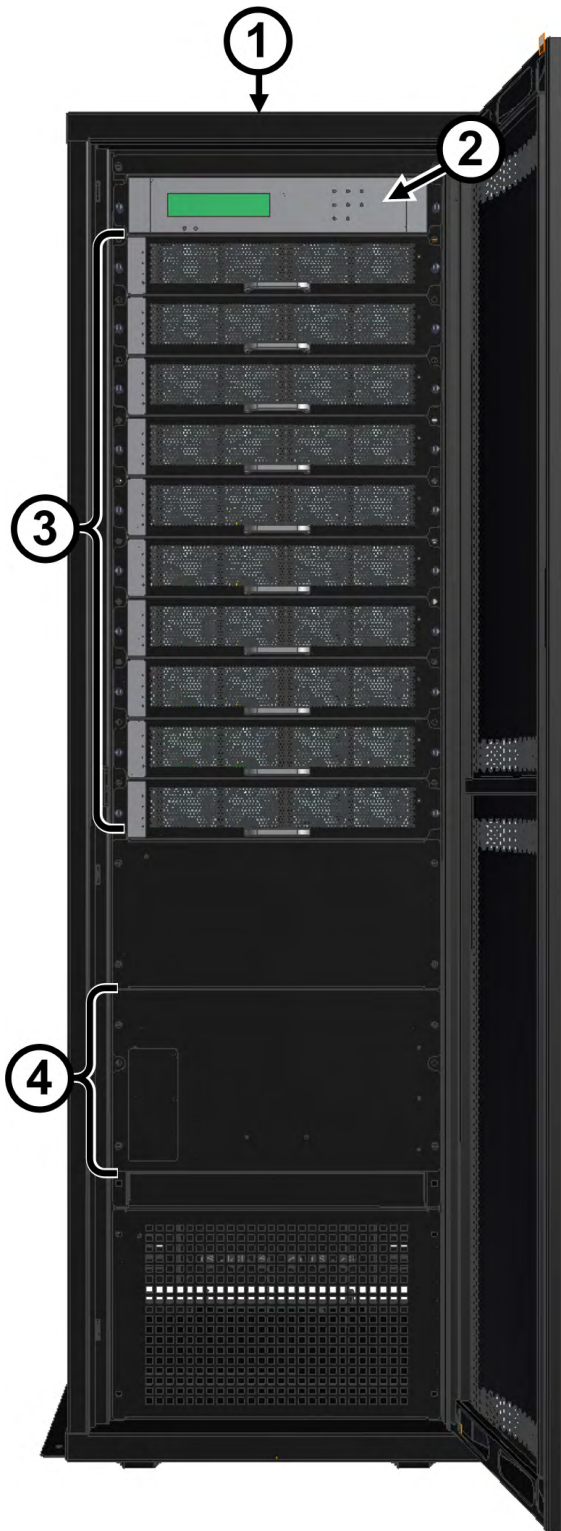

ITEM	DESCRIPTION
1	19-inch cabinet
2	System controller module
3	From 1 to 10 UPS power modules, 10 kVA each
4	Static switch assembly

Figure 1: Main subassemblies of the RM100

1.2 Ac and dc fuses

Ac and dc fuses are located on the rear panel of the UPS, above the terminals. See Figure 19 on page 23.

1.3 Ac input/output main terminals

The main input and output terminals are located at the lower rear of the unit. The terminals are used to connect the ac input and bypass inputs, the battery, and the ac output. See Figure 19 on page 23.

1.4 System controller

The **POWER+** system controller has multiple purposes:

- To allow the user to manage and control the UPS.
- To monitor the parameters of all sections of the **POWER+** via the control panel.
- To collect and summarize data from all sections of the UPS.
- To communicate with external computers for data transfer and operation.

The **POWER+** can work without the system controller but with reduced functionality.

1.5 UPS module (10 kVA / 8 kW)

The UPS module is the core of the **POWER+**, which consists of from one to ten identical modules in parallel depending on capacity requirements.

Each module includes a 3-phase charger with PFC¹ and a 3-phase PWM inverter connected to batteries by a classic dc link. Each module is plug-in and weighs a mere 22 lb. (10 Kg), approximately.

1.6 Static Switch (ST/SW) module

The centralized hybrid Static Switch enables an automatic transfer of the load from the output of the inverters to an alternate source whenever the inverter can no longer supply power to the load. The static switch can transfer high currents at high speed.

¹ PFC is a feature included that reduces the amount of generated reactive power. Reactive power operates at right angles to true power and energizes the magnetic field. Reactive power has no real value for an electronic device, but electric companies charge for both true and reactive power resulting in unnecessary charges.

In power factor correction, the power factor (represented as "k") is the ratio of true power (kWatts) divided by reactive power (kVA). The power factor value is between 0.0 and 1.00. If the power factor is above 0.8, the device is using power efficiently. A standard power supply has a power factor of 0.70-0.75, and a power supply with PFC has a power factor of 0.95-0.99.

2. BATTERY

The POWER+ battery bank is used as a backup in the event that the utility ac input fails. The batteries are housed in an external cabinet (cat. no. **29B020128-PPE**) next to the POWER+ cabinet. The batteries are charged by the rectifier that supplies both the inverter and the battery charger. Batteries should always be located next to the UPS.



WARNING - RISK OF ELECTRIC SHOCK!

Do not open the battery cabinet. Keep it locked..Servicing of batteries should be performed or supervised by personnel knowledgeable of batteries and the required precautions. Keep unauthorized personnel away from batteries.



CAUTION - WARNING - RISK OF ELECTRIC SHOCK!

Do not touch uninsulated battery terminals.



CAUTION

Do not dispose of battery or batteries in a fire. The battery may explode. For proper disposal, contact your local recycling / hazardous waste center.



CAUTION

Do not open or mutilate the battery or batteries. Released electrolyte is harmful to the skin and eyes, and is toxic.



CAUTION

Batteries are heavy. Move them with care. Dropping a battery can result in injury and may damage the battery.

CAUTION: A BATTERY CAN PRESENT A RISK OF ELECTRICAL SHOCK AND HIGH SHORT-CIRCUIT CURRENT. THE FOLLOWING PRECAUTIONS SHOULD BE OBSERVED WHEN WORKING ON BATTERIES.

- Remove watches, rings, and other exposed metal objects from the body.
- Use tools with insulated handles.
- Wear rubber gloves and boots.
- Do not lay tools or metal parts on top of the batteries.
- Disconnect the charging source before connecting or disconnecting battery terminals.



ATTENTION - RISQUE DE DÉCHARGE ÉLECTRIQUE !

Ne pas ouvrir le boîtier de la batterie, gardez l'armoire verrouillée. L'entretien des batteries doit être effectué ou supervisé par un personnel qualifié de batteries et les précautions nécessaires. Garder le personnel non autorisé loin des batteries.



ATTENTION - AVERTISSEMENT - RISQUE DE DÉCHARGE ÉLECTRIQUE !

Ne touchez pas les bornes non isolées de batterie.



ATTENTION

Ne vous débarrassez pas de la batterie ou des batteries dans un feu. La batterie peut éclater. Pour la disposition appropriée, entrez en contact avec votre centre de recyclage de gens du pays/perte dangereuse.



ATTENTION

N'ouvrez pas ou ne mutilez pas la batterie ou les batteries. L'électrolyte libéré est nocif à la peau et aux yeux, et est toxique.



ATTENTION

Les batteries sont lourdes. Déplacez-les avec soin. La chute d'une batterie peut avoir comme conséquence les dommages et peut endommager la batterie.

ATTENTION : UNE BATTERIE PEUT PRÉSENTER UN RISQUE DE CHOC ÉLECTRIQUE ET DE COURANT ÉLEVÉ DE SHORT-CIRCUIT. ON DEVRAIT OBSERVER LES PRÉCAUTIONS SUIVANTES EN TRAVAILLANT AVEC LES BATTERIES.

- Enlevez les montres, les anneaux, et d'autres objets exposés en métal du corps.
- Utilisez les outils avec les poignées isolées.
- Portez les gants et les initialisations en caoutchouc.
- N'étendez pas les outils ou les pièces en métal sur les batteries.
- Débranchez la source de remplissage avant de relier ou débrancher des bornes de batterie.

2.1 Dc wiring

To connect the battery cabinet to the UPS, use wire size of 300 kcmils, rated for 600 V, 75 °C copper wire.

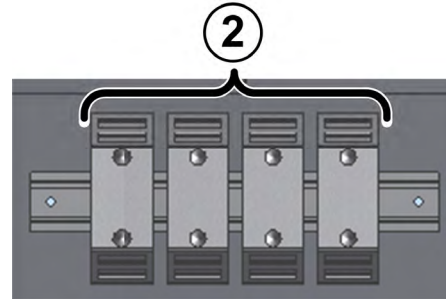
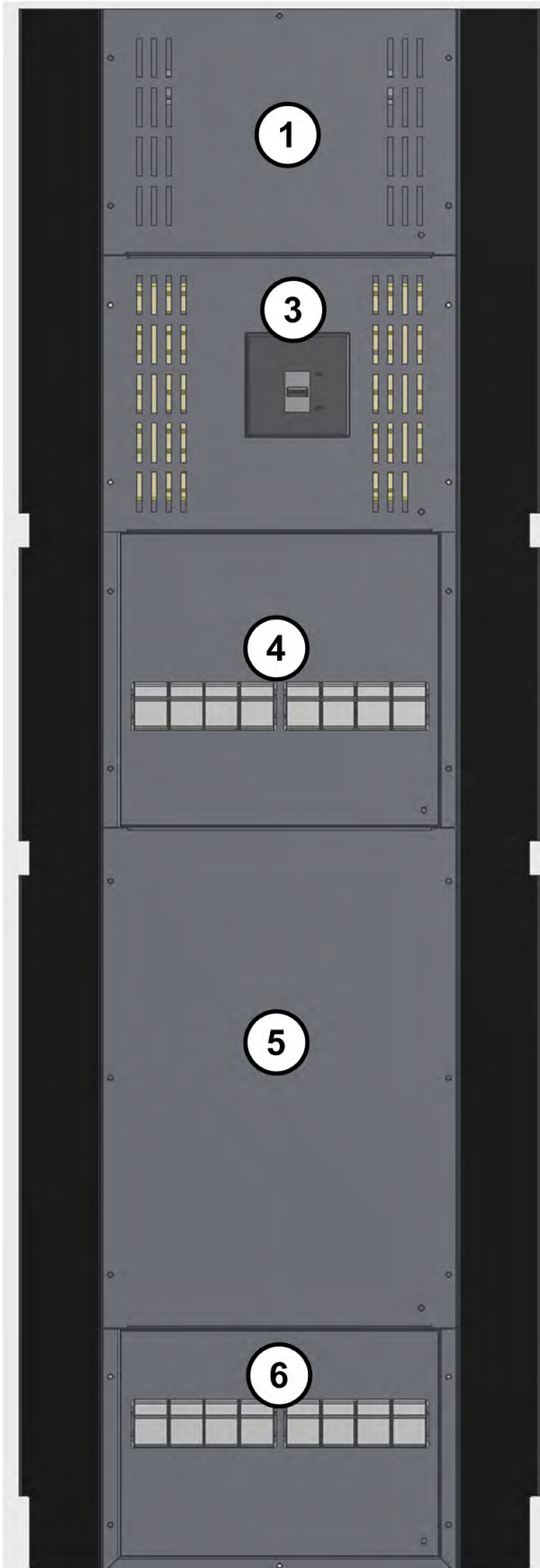

ITEM	DESCRIPTION
1	Cover for terminal connections
2	Terminals, uncovered (from left to right): plus (+) battery box 1 minus (-) battery box 1 plus (+) battery box 2 minus (-) battery box 2
3	Circuit breaker.
4	Fuses
5	Cover for bus bars
6	Fuses

Figure 2: Battery cabinet

- The battery cabinet (cat. no. **29B020128-PPE**) contains two battery boxes.
- Each battery box contains eight drawers of batteries.
- Each drawer contains eight batteries.

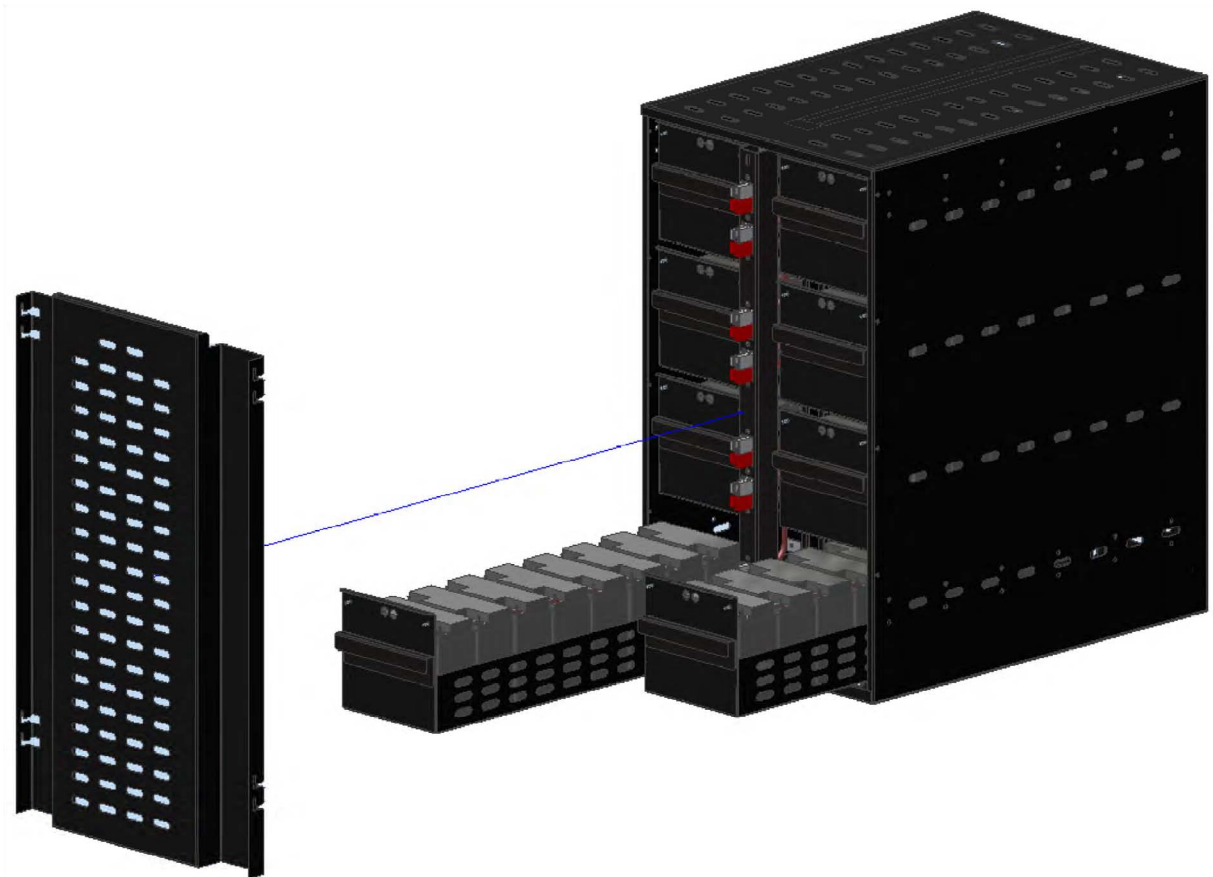

Figure 3: One battery box

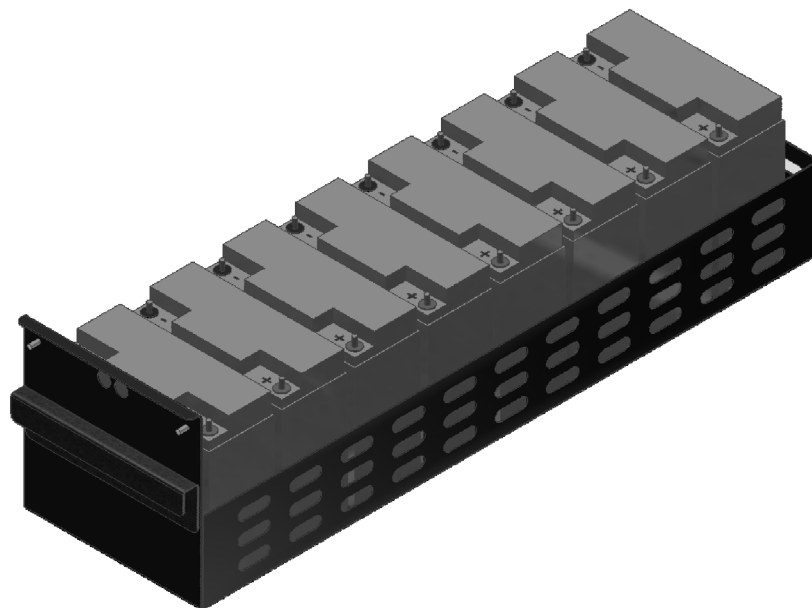

Figure 4: One battery drawer

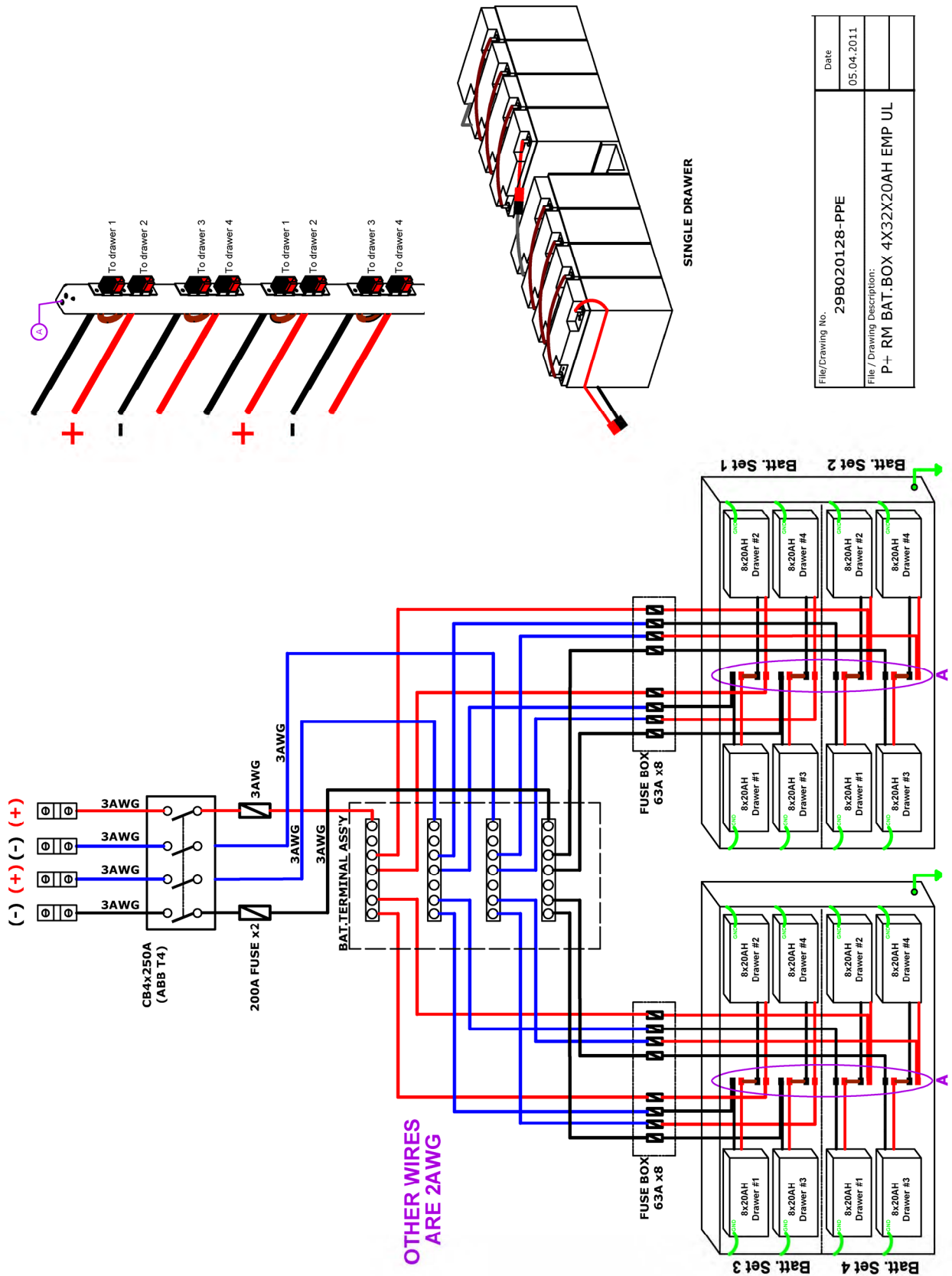
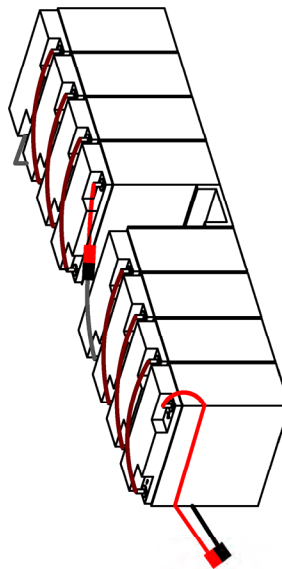

Figure 5: Battery cabinet wiring



SINGLE DRAWER

File/Drawing No.	29B020128-PPE	Date	05.04.2011
File / Drawing Description:		P+ RM BAT :BOX 4X32X20AH EMP UL	

Free air circulation around the batteries is extremely important for proper battery safety. If the Power+ is installed in a cabinet, the cabinet must have sufficient ventilation openings to permit free air circulation around the batteries.

This means that solid glass or acrylic-type door panels are not suitable for a cabinet housing the Power+, neither for the front cabinet door nor for the rear door.

If the UPS is delivered without batteries, Gamatronic is not responsible for any damage or malfunction due to incorrect wiring of the batteries.

Protect the batteries from moisture, dampness, and foreign substances.

The temperature of the battery's surroundings influences the batteries' useful lifetime.

Table 1: Battery lifetime vs environmental temperature

ENVIRONMENTAL TEMPERATURE	ACHIEVABLE PERCENTAGE OF BATTERY'S RATED LIFETIME
68 °F (20 °C)	100 %
86 °F (30 °C)	50 %
104 °F (40 °C)	20 %

Please refer to the battery manufacturer's data sheets for additional information.

When replacing internal batteries, replace with the same number and type!

BATTERY MANUFACTURER	PART NUMBER
CSB Battery Co., a.k.a CSB Battery Technologies a.k.a CSB Battery Europe	HR 1290W
	BATTERY DESCRIPTION
	12 V, 90 W, 22.5 Ah, valve-regulated lead-acid

2.2 Battery replacement instructions

To replace the batteries in the battery cabinet (cat. no. 29B020128-PPE):

1. Turn off load devices (recommended).
2. Disconnect the ac input to the UPS (recommended).
3. On the rear of the battery cabinet, switch OFF the battery cabinet circuit breaker (item 3 in Figure 2).
4. Unlock and open the rear door of the battery cabinet.
5. On the battery cabinet, open all of the fuse holders (items 4 and 6 in Figure 2).
6. Unlock and open the front door of the battery cabinet.
7. Remove the two large protective plates covering the battery drawers.
8. You will see that each battery drawer is connected to the central column by a pair of thick cables with red and black connectors. For each battery drawer, disconnect the red and black connector from the central column.
9. Disconnect the green and yellow ground wire from each battery drawer.
10. To check the batteries to see which of them need to be replaced, you must remove each battery drawer one-by-one and test the batteries in each drawer. Replace the batteries that need replacing and reinsert the drawer.



**WARNING – THE BATTERY DRAWERS ARE VERY HEAVY!
REMOVING A BATTERY DRAWER REQUIRES AT LEAST TWO PERSONS!
DO NOT TRY TO REMOVE A BATTERY DRAWER ALONE!**

11. After all of the batteries have been tested (and any that need replacing have been replaced), and the drawers have all been reinserted into the battery cabinet, reconnect the ground wire to each battery drawer.
12. Reconnect each drawer's red-and-black connector cable to the cabinet's central column.
13. Replace the large protective plates covering the battery drawers.
14. Lock the front door of the battery cabinet.
15. At the rear of the battery cabinet, close the fuse holders.
16. Lock the battery cabinet's front door.
You can now switch ON the battery cabinet circuit breaker.

3. OPERATING MODES

The **POWER+** UPS functions to supply ac electrical power to your load.

While using the **POWER+**, three modes of operation are possible:

- Normal operation
- Battery operation
- Bypass operation

All three operation modes are encountered during normal UPS use to constantly provide regulated voltage to the load.

In the normal operation mode, the UPS provides total power protection for the load.

In the battery operation mode, the load power is supplied by the battery.

In the bypass mode, power is transferred directly from the ac input to the load, bypassing the inverter. In this mode, there is no protection but it is useful for short-term operation. When power is restored, the UPS returns to normal operation.

In addition to the three operation modes that are set automatically by the UPS, two additional modes can only be invoked via manual intervention: by either the user or a technician:

- Maintenance bypass
- Emergency Power Off (EPO)

Details of each mode of operation are described in the sections below.

3.1 Normal operation

The UPS is almost always in normal operation mode. The load receives its power from the inverters that supply stabilized voltage, protected from spikes and irregularities in the ac input. The ac input system feeds the charger which supplies dc power to the inverter, while concurrently charging the batteries.

3.2 Battery operation

During battery operation, the load continues to receive power from the inverters, but the dc input to the inverter is taken from the batteries, instead of from the rectifier.

The batteries are galvanically connected by dc link to the inverter and the charger. The dc inherently remains constant when the ac input supply drops out, without any switching devices.

The duration of the battery operation is determined by the load demand and the battery capacity.

3.3 Bypass operation

During bypass operation, the load receives power directly from the ac input via the static switch.

Whenever the inverters cannot provide power to the load, either due to an overload or a short-circuit in the load, transfer to the ac input is automatic. As soon as the problem is corrected, the load is transferred back to the inverter.

3.4 Maintenance bypass mode

In maintenance bypass mode, the UPS output terminals continue to supply power to the load, but the interior of the UPS is disconnected from the main power flow. This enables a maintenance technician to work safely on the UPS without any interruption of power to the load.

For more information on maintenance bypass mode, see section 13, Maintenance bypass mode, starting on page 162.

4. USER INTERFACE

This section describes the buttons and indicators used to operate the **POWER+**.

4.1 Control Panel

The **POWER+** Control Panel, located on the front of the controller, provides the user with an interface to the **POWER+** system. It includes an LCD display, a keypad, buttons and indicators for monitoring and controlling the UPS configuration and functions. The control panel is aimed both at the end-user as well as the service engineer. All of the **POWER+** parameters can be viewed on the control panel.

Use of the **POWER+** Control Panel is described in detail in Chapter 7 beginning on page 61.

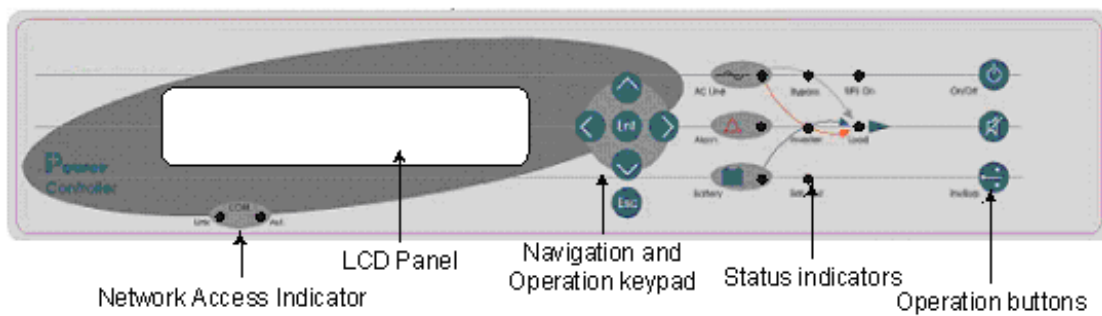

Figure 6: Control panel

4.2 UPS Module Panel

The UPS module panel, located on the front of each UPS module, provides the user with the status of that module

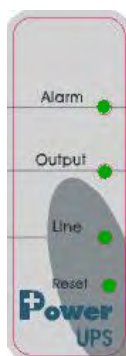

Figure 7: UPS module panel

4.3 Static Switch Panel

The static switch panel, located on the front of static switch module, provides the user with the status of the static switch module. All the functions and indications are available on the **POWER+** Control Panel.

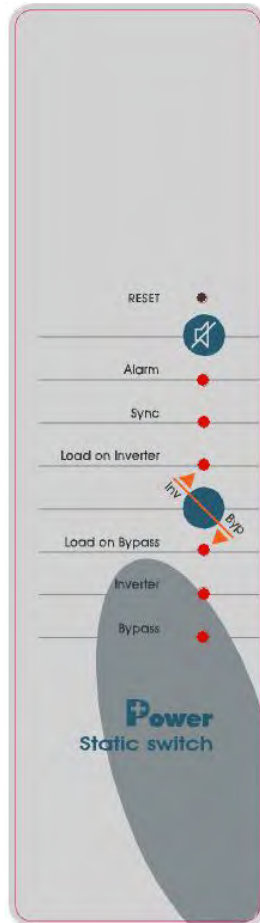

Figure 8: Static switch panel

4.4 POWER+ control screen

The **POWER+** control screen is illustrated below. It is part of the control panel described on page 13.

How to read and understand the **POWER+** control screen is described in detail in Chapter 7, **POWER+** Control Panel, beginning on page 61

The control screen provides menus and displays all aspects of the **POWER+** systems input, output and static switch as well as operational details.

The figure below shows the **POWER+** 3-phase display.

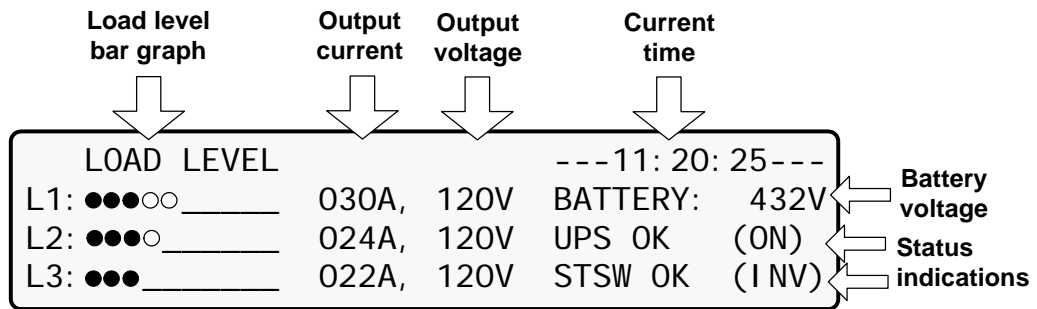

Figure 9: **POWER+** control screen

This is how the control screen appears while the UPS is running normally.

4.4.1 Load-level bar graph

The load-level bar graph on the default screen display illustrates the approximate load on each output phase of the UPS, as a percent of the maximum available output for each phase.

The load on each phase is represented by a series of from 1 to 10 dots. Each dot represents about 10 % of the maximum available output per phase.

The dots can be either filled in (black) or clear (white). The number of black dots represents kW, and the number of black and white dots together represents kVA.

For example, in Figure 9, the load on **Line 2** is 30 % (3 black dots) of the maximum in terms of kW, and 40 % (3 black dots plus 1 white dot) of the maximum in terms of kVA.

To compute the approximate value in kW or kVA of each dot:

1. Compute the maximum load per phase =
$$\frac{10 \text{ kVA [or 8 kW]}}{3 \text{ phases}} \times (\text{total \# of modules} - \text{redundant \# of modules})$$
2. Dividing the maximum load per phase by 10 gives you the value of 1 dot.
Example: Assume a system with 10 modules, 2 of which are redundant.
$$10 \text{ kVA} / 3 \times (10-2) = 3.33 \times 8 = \text{maximum load per phase} = 26.67 \text{ kVA.}$$

Thus, $26.67 / 10 = 2.67 \text{ kVA}$ is the approximate value of each dot.

4.5 Navigation and Operation Keypad

The navigation and operation keypad works in conjunction with the control screen. It allows you to navigate through the available menus using the ◀ ▶ ▲ ▼ direction arrow buttons and the Enter **Ent** and Escape **Esc** buttons to select or quit, respectively.

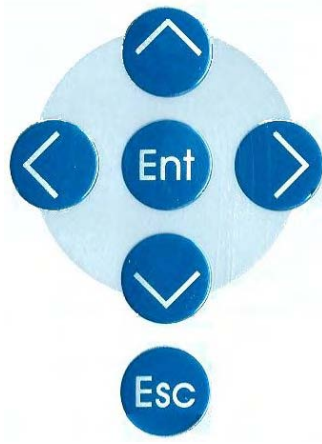

Figure 10: Navigation and operation keypad

4.6 Status Indicators

The status indicators show precisely what is running and how the UPS is providing power to the load.

The diagram below shows the power source and destination routes in use for each of the 3 automated operation modes.

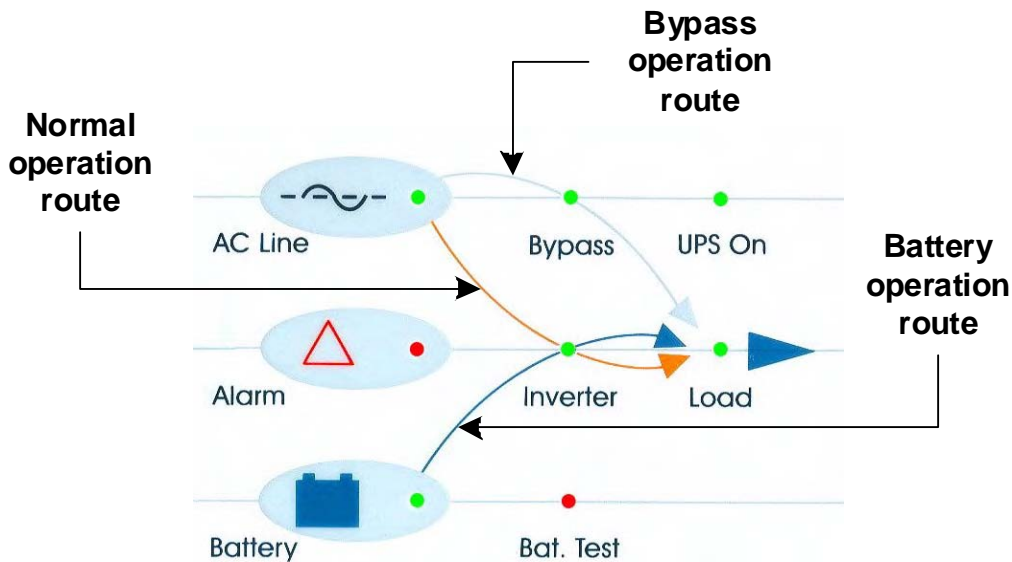

Figure 11: Status indicators

Table 2: Status indicators



Ac Line	Green – Shows that the ac input is present and within range
Alarm	Red – Flashes to indicate general alarm condition
Battery	Green – Shows that the battery is in discharge mode
Bypass	Green – Shows that the load is supplied from the ac input
Inverter	Green - Shows that the inverter is supplying power to the load
Bat. Test	Blinking Red – Shows that a battery test is in progress Steady Red – Battery test failure
UPS On	Green – Indicates that the UPS is running
Load	Green – Indicates that ac voltage is available at the output

4.7 Operation Buttons

The operation buttons illustrated below are “soft” switches.

- On/Off resets the entire UPS
- Alarm silence shuts the alarm sounder
- Inv/Byp allows the maintenance engineer to manually change the operation mode
-

Table 3: Operation buttons

 On/Off	UPS ON/OFF switch
	Alarm silence
 Inv/Byp	Inverter/Bypass manual switch over

4.8 Network Access Indicator

The network access indicator shows whether the network connection is available and whether it is active.



Figure 12: Network access indicator

Table 4: Network access indication

Link	Red – Indicates the presence of a network connection link
Act	Green – Indicates that the network is active

4.9 POWER+ Operation Modes

4.9.1 Normal Operation

During normal operation, the UPS draws power from the ac line, feeds dc to the inverter, which provides ac to the load.

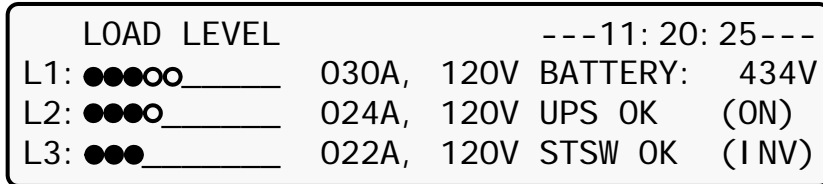

Figure 13: POWER+ control screen in normal operation

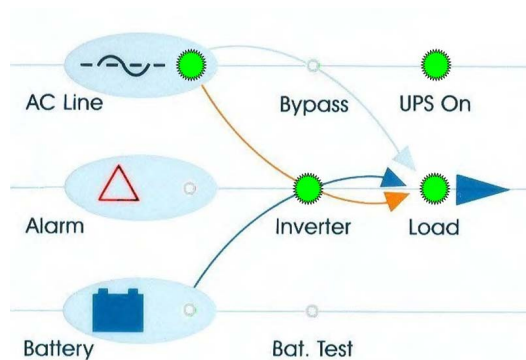

Figure 14: Normal operation indication

4.9.2 Battery Operation

During battery operation the battery supplies dc to the inverter, which then provides ac to the load.

The red alarm flashes to indicate the abnormal status.

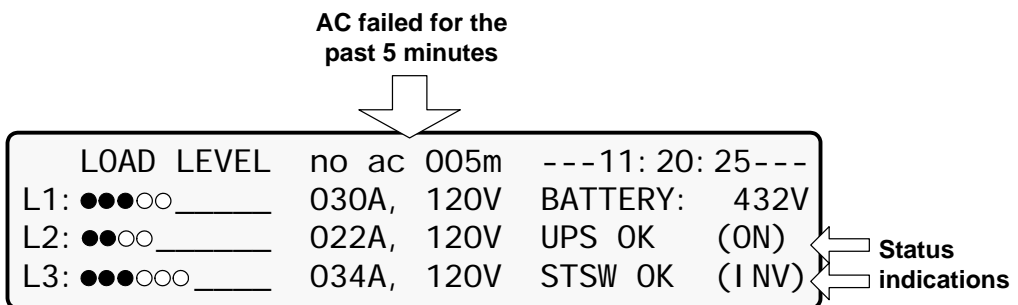

Figure 15: AC power failure

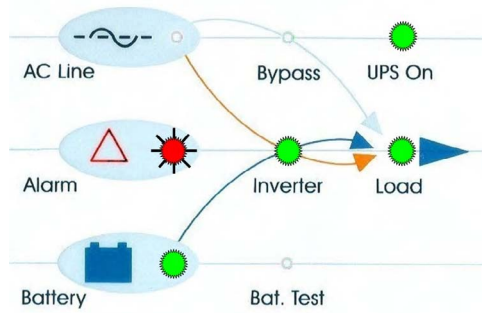

Figure 16: AC power failure indication

4.9.3 Bypass Operation (Automatic)

During Bypass operation, the ac feeds the load via the bypass static switch. The red alarm flashes to indicate abnormal status.

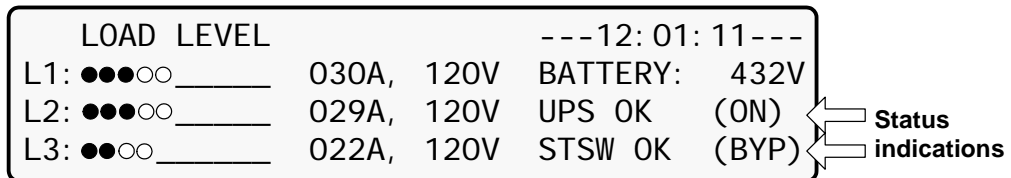

Figure 17: UPS in Bypass mode

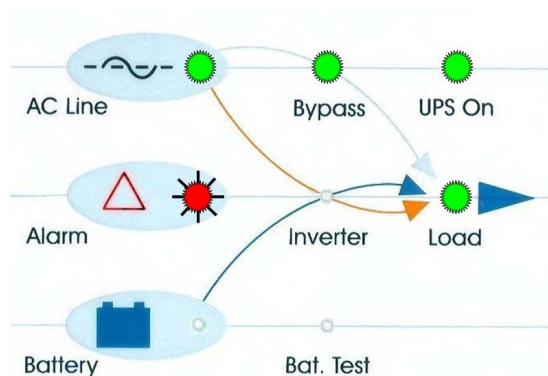

Figure 18: Red alarm flashing

4.9.4 Bypass Operation (Manual)

If the Power+ is manually switched to bypass operation by pressing the Inv/Byb button, the load is transferred to the mains ac input line. Transfer back to normal operation must be performed manually. The red alarm indicator flashes (Figure 18).

4.9.5 Emergency Power off – EPO (Manual)

The EPO button is for use by the user, in emergencies only. The EPO button cuts the supply to the load with immediate effect and cannot be reset. Once switched OFF by the EPO, the **POWER+** must be restarted manually.

See section 5.6 for more information on use of an EPO switch.

5. SYSTEM INSTALLATION



WARNING! This UPS is intended for installation in a temperature-controlled, indoor area that is free from conductive contaminants.



ATTENTION! Cet onduleur est conçu pour une installation dans une température contrôlée, espace intérieur qui est exempt de contaminants conducteurs.

5.1 Cabling



WARNING! RISK OF ELECTRICAL SHOCK OR INJURY! INSTALLATION MAY BE PERFORMED BY QUALIFIED TECHNICIAN ONLY!

USE REQUIRED WIRING SIZE ACCORDING TO THE NATIONAL ELECTRIC CODE, NSI/NFPA 70.

FOR SYSTEMS UP TO 100 kVA:

Ac wiring: 500 kcmils maximum, 600 V, 75 °C copper wire.
Use a torque wrench to tighten the terminals to 270 lbs/inch (30.5 newton-meters).
This wire-size recommendation is based on the maximum current for a 100 kVA system.

Choose the size of the protective circuit breakers according to the actual current as determined by the system capacity in kVA – See Table 7, page 33.

Battery cables: 300 kcmils maximum, 600 V, 75 °C copper wire.



AVERTISSEMENT ! RISQUE DE CHOC ÉLECTRIQUE OU DE DOMMAGES ! L'INSTALLATION PEUT ÊTRE EFFECTUÉE PAR LE TECHNICIEN QUALIFIÉ SEULEMENT !

**EMPLOYEZ LE CABLAGE REQUIS SELON
LE CODE ÉLECTRIQUE NATIONAL, NSI/NFPA 70.**

POUR LES SYSTÈMES À 100 kVA:

Câblage ac: 500 kcmils maximum, 600 V, 75 °C le fil de cuivre.
Utilisez une clé dynamométrique pour serrer les bornes à 270 lb/po (30,5 newtons-mètres).

Cette recommandation fil-taille est basée sur le courant maximum pour un système de 100 kVA.

Choisissez la taille des disjoncteurs de protection en fonction de la valeur réelle du courant tel que déterminé par la capacité du système en kVA. – voir le Table 7, page 33.

Câblage de batterie: 300 kcmils maximum, 600 V, 75 °C le fil de cuivre.
Utilisez une clé dynamométrique pour serrer les bornes à 270 lb/po (30,5 newtons-mètres).

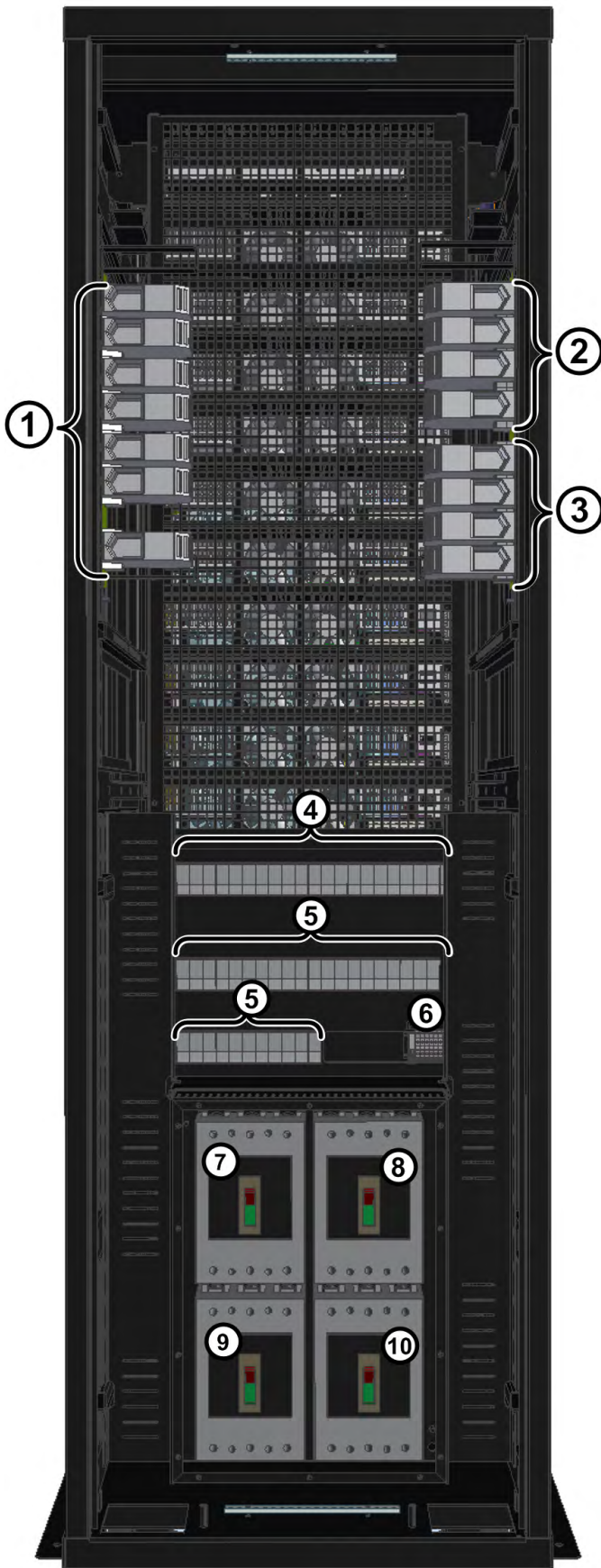

ITEM	DESCRIPTION
1	Ac input terminals. From top to bottom: Rectifier ac input L1 Bypass ac input L1 Rectifier ac input L2 Bypass ac input L2 Rectifier ac input L3 Bypass ac input L3 Neutral
2	Ac output terminals. From top to bottom: L1, L2, L3, N.
3	Terminals for external battery. From top to bottom: plus (+), minus (-), plus (+), minus (-).
4	Dc fuses for modules.
5	Ac fuses for modules.
6	Special connections (see section 5.6).
7	Rectifier ac input CB.
8	Bypass ac input CB
9	Ac output CB
10	Maintenance bypass CB

Figure 19: RM100 3x208 V, rear view

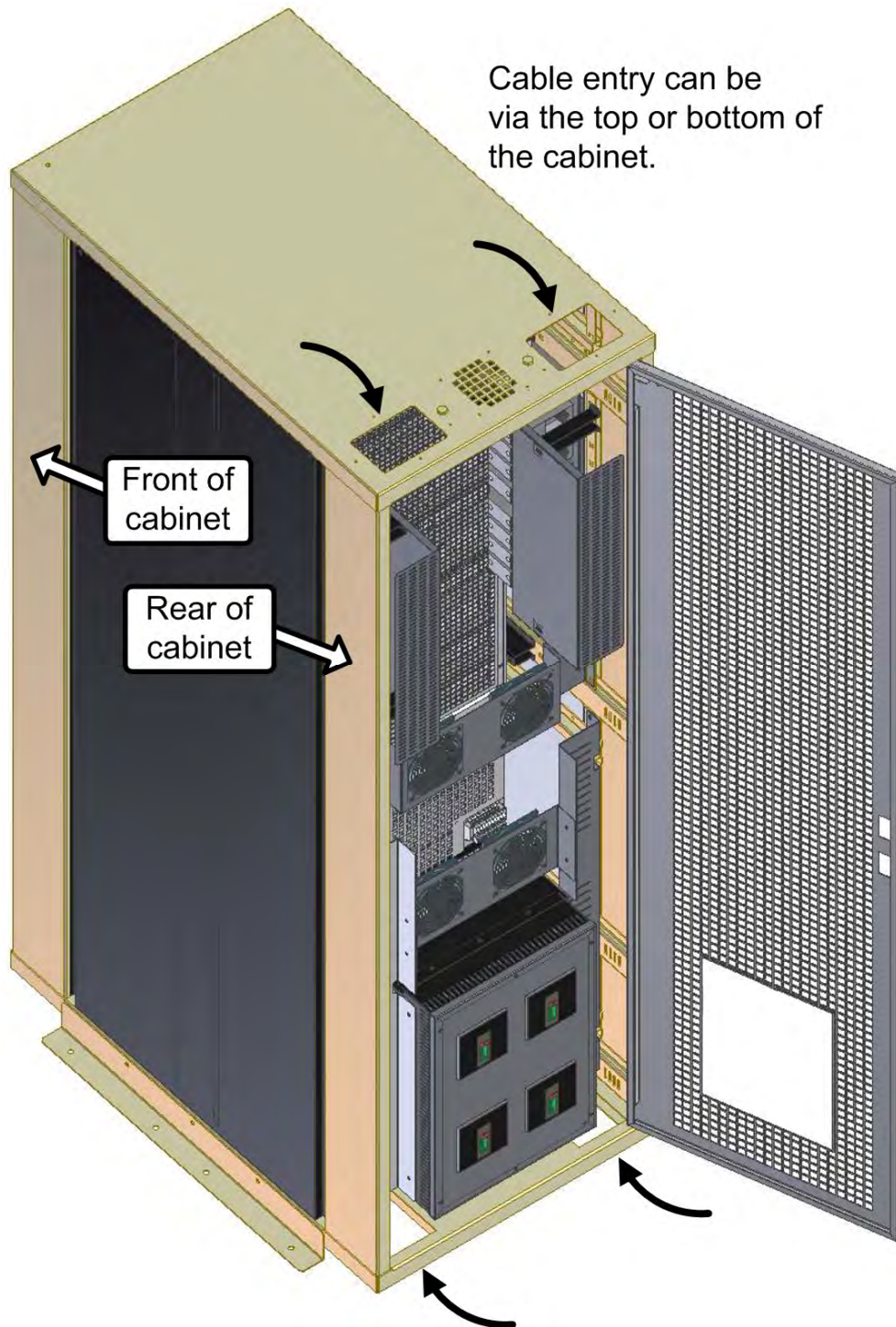

Figure 20: Cable entry from the top or bottom of UPS cabinet

Figure 21 (3-3 configuration) below illustrates the cabling of the POWER+ system to the mains electricity cabinet.

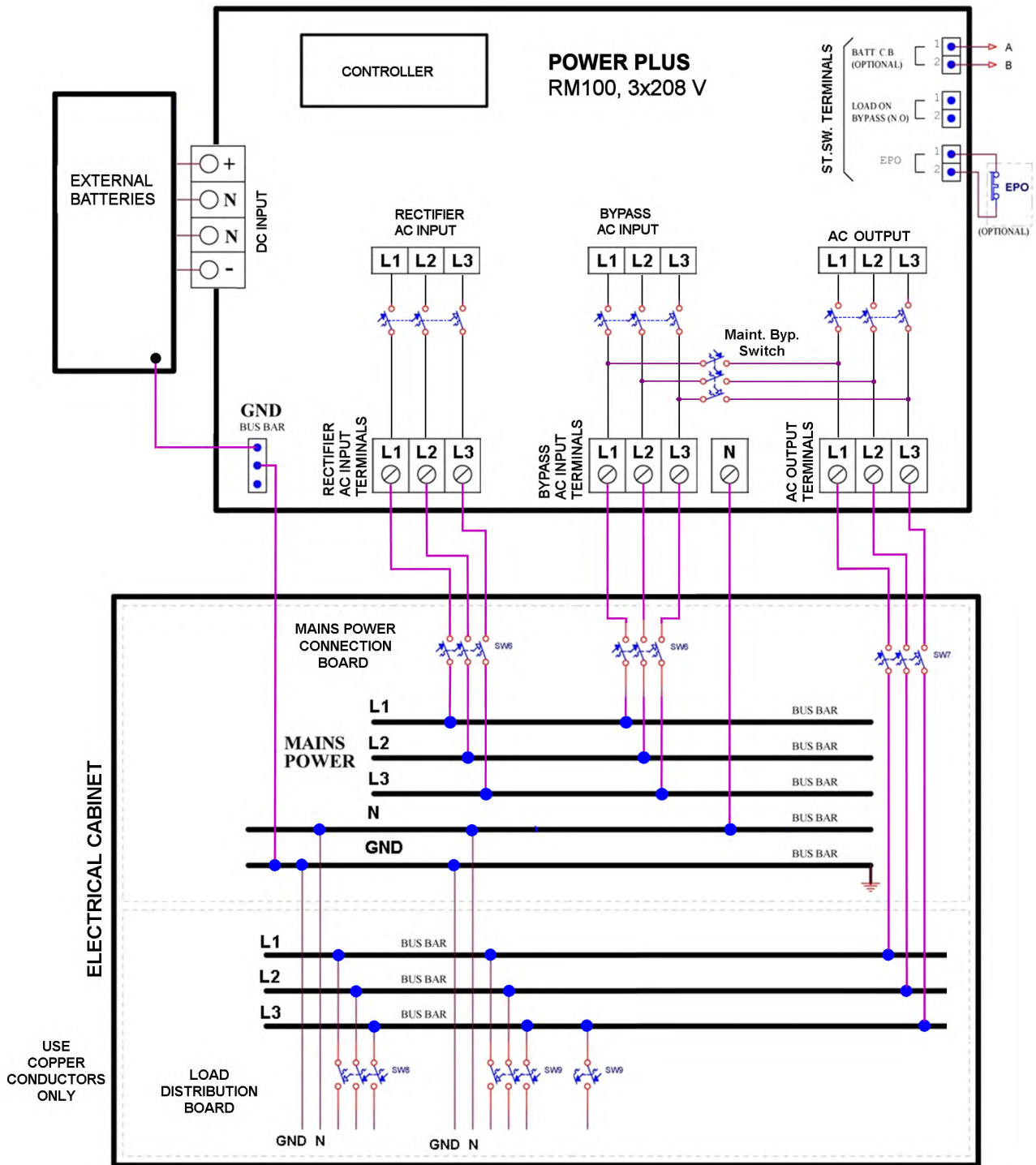

Figure 21: Connection diagram for 3-3 configuration

Note: If you intend to install the PowerPlus in a 2-2 configuration it is important that you first consult with Gamatronic's engineering department. The power output in the 2-2 configuration is limited to 50 kVA.

5.2 The Power+ always requires a neutral line

During both installation and operation of the Power +, a neutral line must always be connected to the UPS. This neutral line shall be connected during the entire period that the UPS is working, and shall not be disconnected at any time!

Caution: If at any time the neutral line becomes disconnected, there will be no input or output reference voltage, because the input neutral line and the output neutral line are physically linked together. That may result in system defining its own reference voltage, which will be set by the load distribution between the three phases. ***This can result in serious damage to the UPS.***

5.2.1 A 4-pole switch might disconnect the neutral line

WARNING! If you have a mains-to-generator **four-pole** switching system, you are in danger of having the **neutral line disconnected** when the four-pole switch is operated. This can result in the problems described above.

To avoid these problems, we strongly recommend that, if you use a four-pole mains-to-generator switching system, you install an isolation transformer that will constantly provide the UPS with a neutral line.

Figure 22 on page 27 illustrates the wrong way to connect the UPS with a grounded-neutral generator.

Figure 23 on page 28 illustrates an acceptable connection solution if you already have a grounded-neutral generator.

Figure 24 on page 29 shows the preferred generator (neutralized, not grounded) and the preferred connection (three-pole).

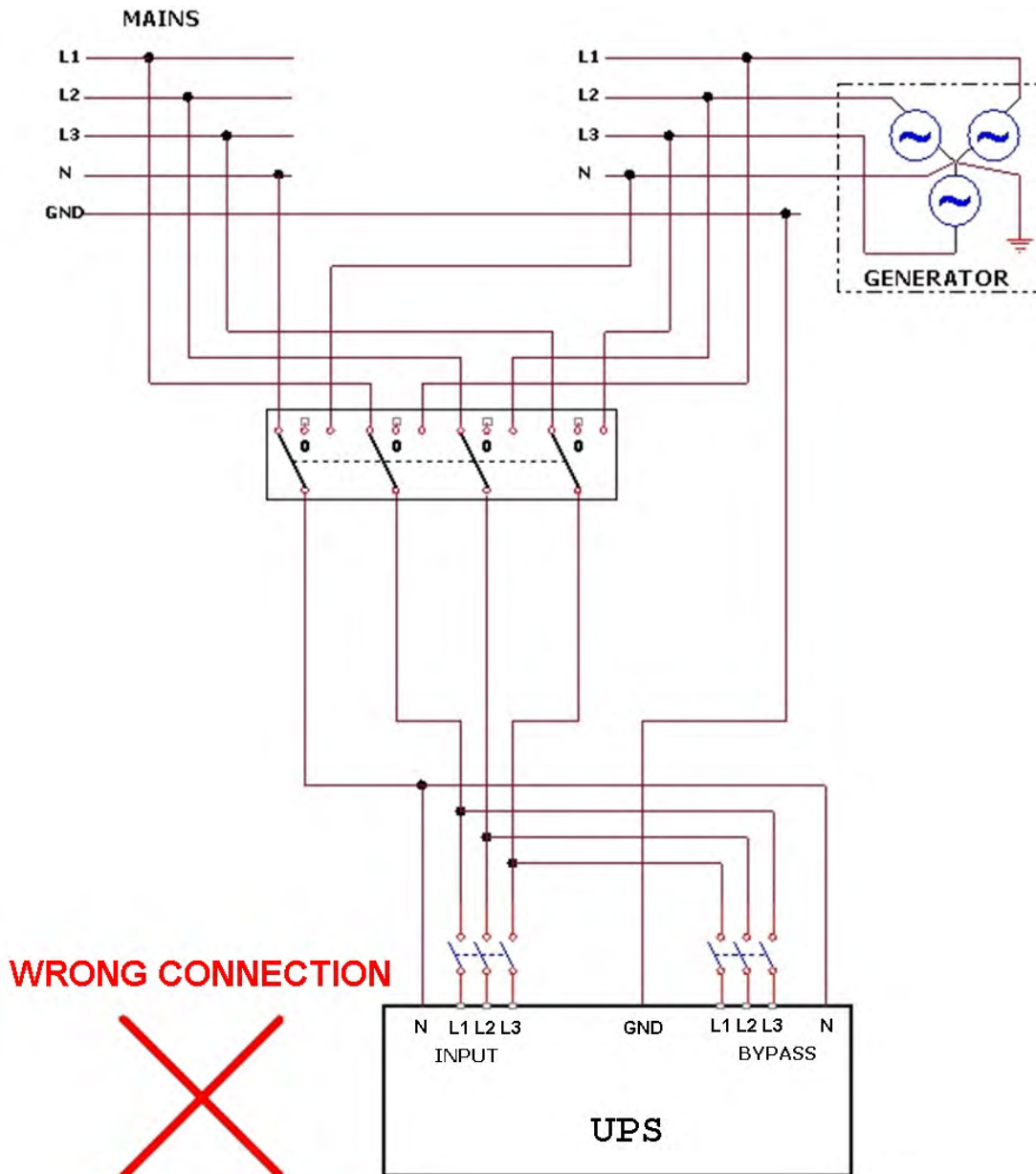

Figure 22: Wrong way to connect UPS with four-pole switch

WARNING!

A 4-pole switch may disconnect the neutral line if improperly connected!

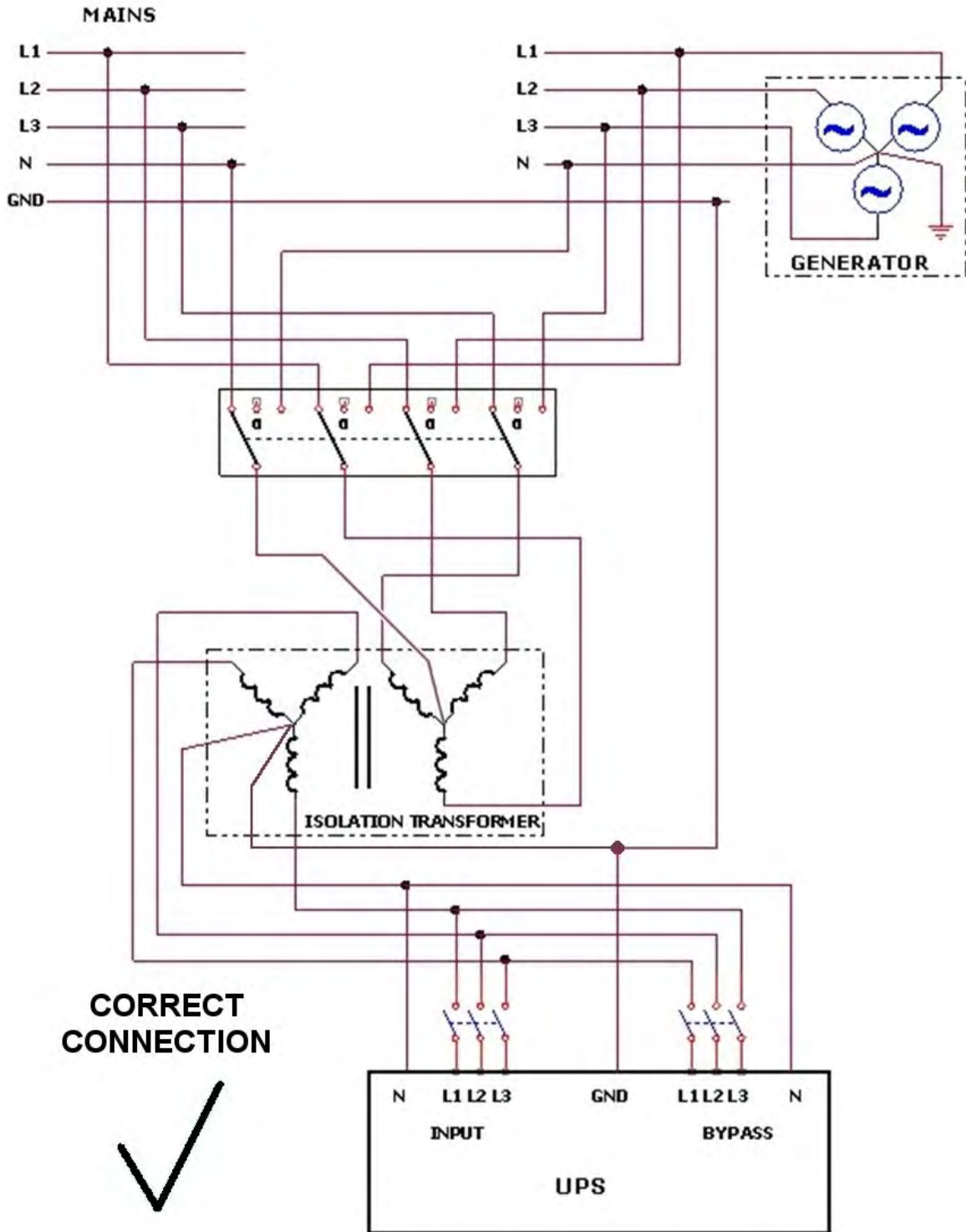

Figure 23: Acceptable connection for grounded generator and 4-pole switch

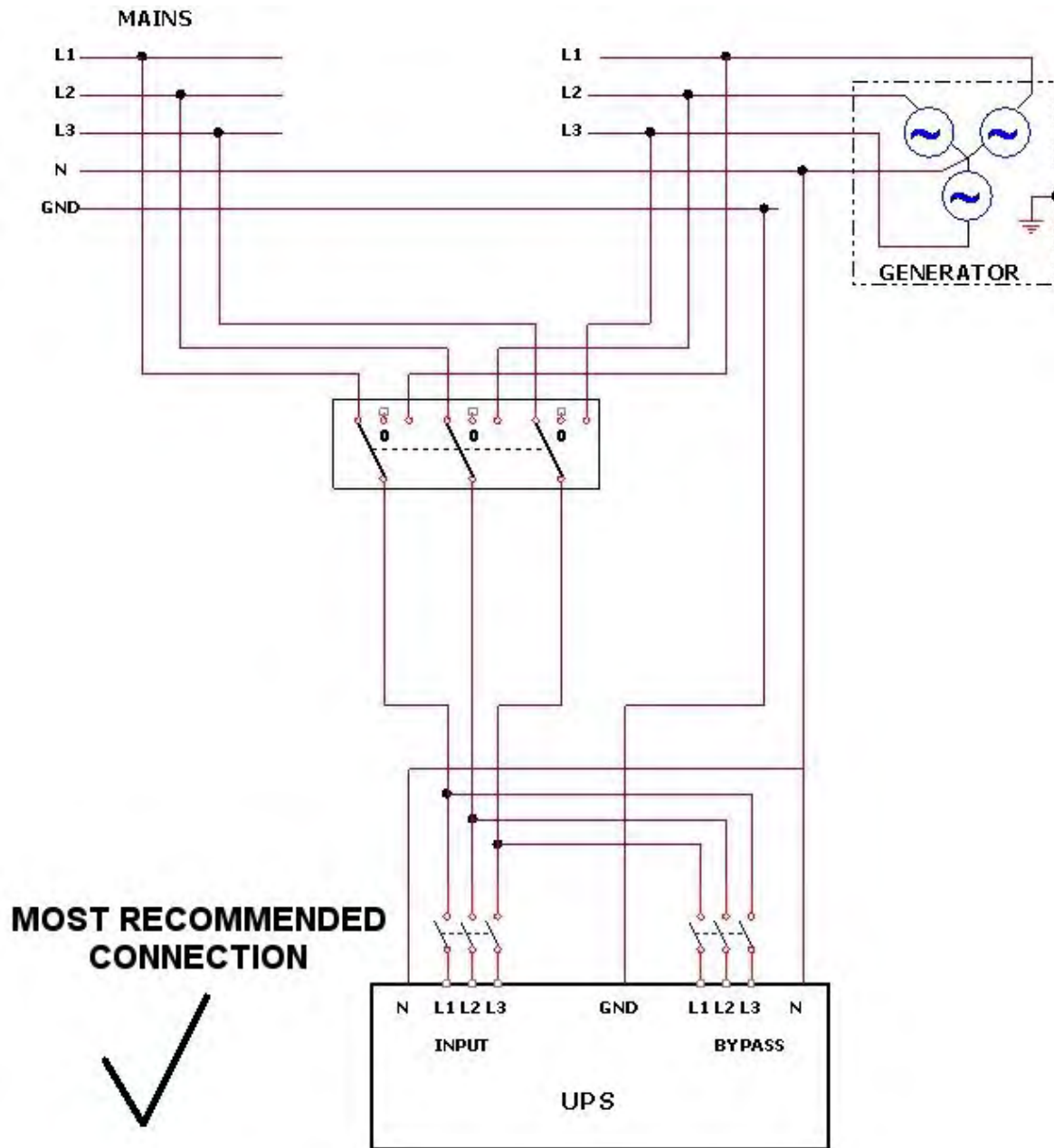

Figure 24: Preferred generator (neutralized) and connection (3-pole)

5.3 Ground connections

There are three ground connections that must be made:

- Between a ground stud on UPS cabinet and the building ground.
- Between a ground stud on UPS cabinet and the electrical board ground line (or the ground connection on the load device).
- Between a ground stud on the battery cabinet and the ground bus bar at the bottom rear of the UPS

These ground connections are detailed below.

The ground connections for the doors of the UPS and battery cabinet are already made for you.

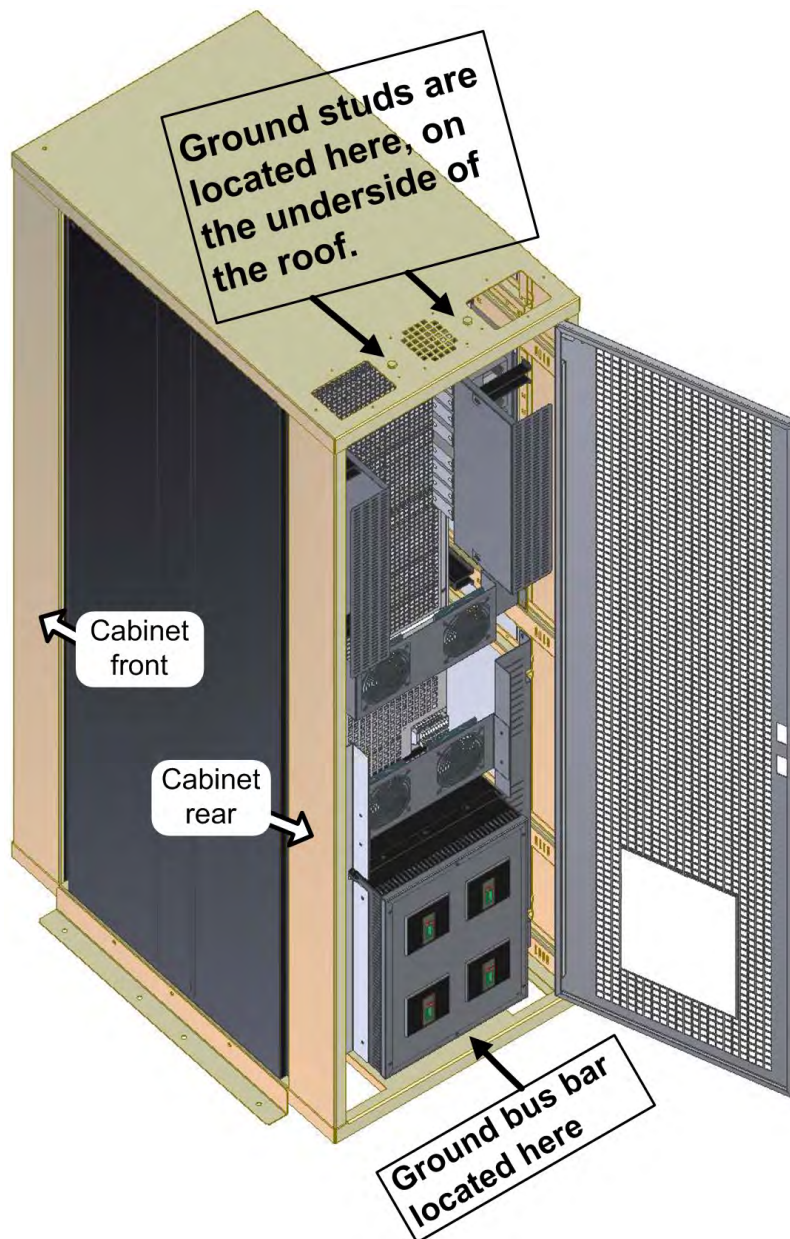

Figure 25: Ground connections on the UPS cabinet roof

Figure 27 through Figure 29 below, and Table 5 and Table 6, detail the ground connections for the UPS and battery cabinet. It is recommended that all ground cables discussed here be finished with cable shoes. For connections to the UPS and battery cabinets, the cable shoes must have a bolt hole (item 1 in Figure 26) suitable for stud of 10 mm diameter and a cable opening (item 2 in Figure 26) suitable for the cable sizes specified in Table 5 and Table 6.

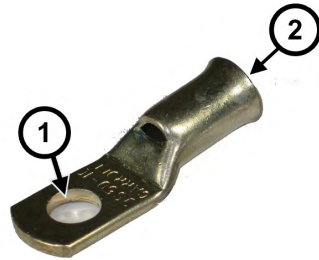

Figure 26: Crimp -type cable shoes recommended for all ground cables

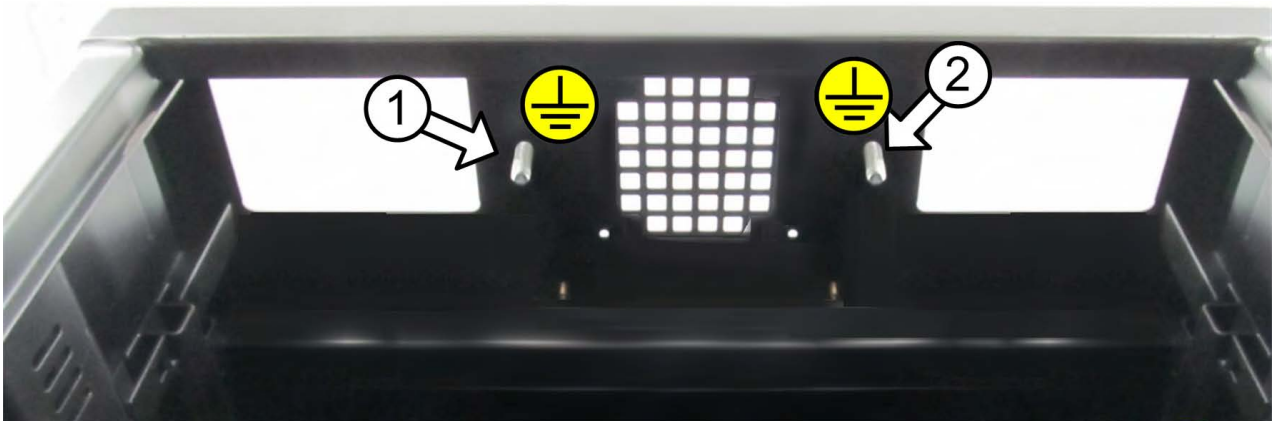

Figure 27: Ground studs on UPS cabinet roof, view from below

Table 5: Key to Figure 27

ITEM #	GROUND NAME	INSTRUCTIONS
1	INPUT GROUND CONNECTION	Insert the building ground cable through the roof or floor of the UPS cabinet (Figure 20) and connect it to this stud (10 mm diam.). Use a cable of 250 kcmil, and a tightening torque of 325 pound-inches (36.7 N-m). Recommended cable shoe: mfr. Panduit, cat.no. S250-76R-5.
2	OUTPUT GROUND CONNECTION	Connect a cable between this ground stud (10 mm diam.) and the ground line on the electrical board. Use a cable of 250 kcmil, and a tightening torque of 325 pound-inches (36.7 N-m). Recommended cable shoe: mfr. Panduit, cat.no. S250-76R-5.

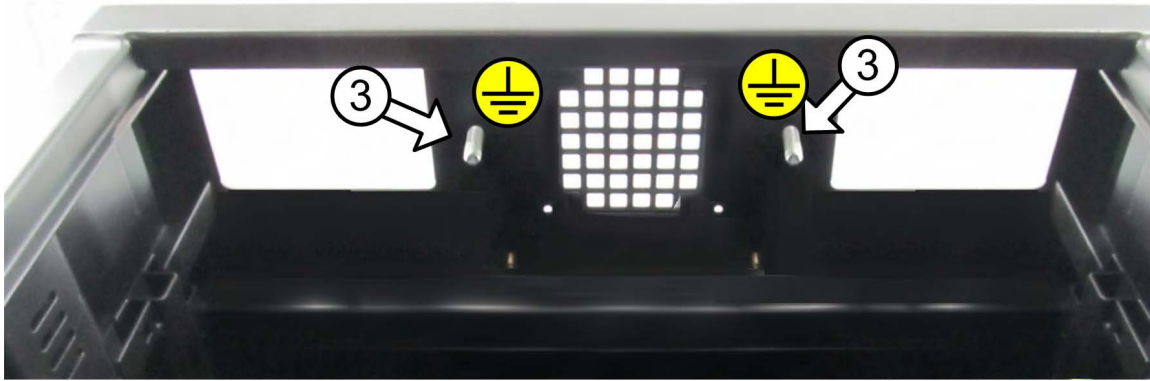

Figure 28: Ground studs on inside of batt. cabinet roof

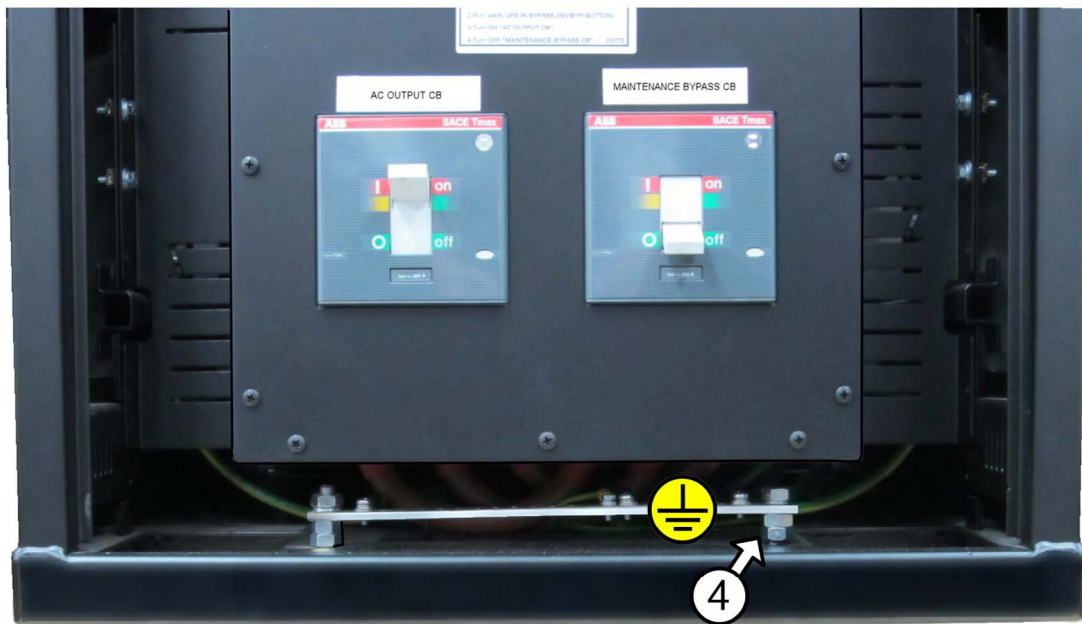

Figure 29: Ground bus bar at base of UPS rear

Table 6: Key to Figure 28 and Figure 29 above

ITEM #	GROUND NAME	INSTRUCTIONS
3	BATTERY CABINET GROUND CONNECTION	Connect a cable to either of the ground studs (10 mm diam.) in the roof of the battery cabinet Figure 28 and connect the other end of the cable to the ground bus bar at the bottom rear of the UPS. Use a cable of 3/0 AWG, and a tightening torque of 250 pound-inches (28.2 N-m) on both ends of the cable. Recommended cable shoe: mfr. Panduit, cat.no. S3/0-76R-5.
4	UPS GROUND BUS BAR	On the UPS's ground bus bar (located at the bottom rear of the UPS) connect the ground cable from the battery cabinet to the ground bolt (10 mm diam.) shown as item 4 in Figure 29. Open the ground bolt, slip on the cable shoe, and reclose the ground bolt. Recommended cable shoe: mfr. Panduit, cat.no. S3/0-76R-5.

5.4 Over-Current Protection



CAUTION!

To reduce the risk of fire, connect the UPS only to a circuit provided with maximum branch circuit over-current protection as indicated in

Table 7, in accordance with the National Electric Code, NSI/NFPA 70.



ATTENTION !

Pour réduire le risque du feu, reliez l'onduleur seulement à un circuit équipé de protection maximum de surintensité de circuit de branche comme indiqué au

Table 7, selon le code électrique national, au NSI/NFPA 70.

5.4.1 Ac wiring

Ensure that the lines into and out of the UPS have protective circuit breakers installed in accordance with the ratings listed in Table 7 for your Power+ model.

The recommended wire size shown in Table 7 is based on a 100 kVA system. The required circuit breaker sizes in Table 7 are based on the actual maximum power of the system in kVA.

Table 7: Required over-current protection

UPS POWER CAPACITY	LINE	FIELD WIRE SIZE AS PER UL *	REQUIRED EXTERNAL CIRCUIT-BREAKER RATING		
10 kVA	Ac input	500 kcmils, 600 V, 75 °C copper wire	35 A		
	Ac input bypass				
	Load				
20 kVA	Ac input		500 kcmils, 600 V, 75 °C copper wire	70 A	
	Ac input bypass				
	Load				
30 kVA	Ac input			500 kcmils, 600 V, 75 °C copper wire	110 A
	Ac input bypass				
	Load				
40 kVA	Ac input		500 kcmils, 600 V, 75 °C copper wire		150 A
	Ac input bypass				
	Load				

50 kVA	Ac input	500 kcmils, 600 V, 75 °C copper wire	175 A					
	Ac input bypass							
	Load							
60 kVA	Ac input		500 kcmils, 600 V, 75 °C copper wire	225 A				
	Ac input bypass							
	Load							
70 kVA	Ac input			500 kcmils, 600 V, 75 °C copper wire	250 A			
	Ac input bypass							
	Load							
80 kVA	Ac input				500 kcmils, 600 V, 75 °C copper wire	300 A		
	Ac input bypass							
	Load							
90 kVA	Ac input					500 kcmils, 600 V, 75 °C copper wire	350 A	
	Ac input bypass							
	Load							
100 kVA	Ac input						500 kcmils, 600 V, 75 °C copper wire	350 A
	Ac input bypass							
	Load							

* The recommended wire size is based on a 100 kVA system. The required circuit breaker size is based on the actual maximum power of the system in kVA.

5.4.2 Dc wiring

To connect the battery cabinet to the UPS, use wire size of 300 kcmils, rated for 600 V, 75 °C copper wire.

5.5 Fuses



WARNING!

To reduce the risk of fire, replacement fuses must be of the same type and rating as the original.



AVERTISSEMENT !

Pour réduire le risque du feu, les fusibles de rechange doivent être du mêmes type et estimation que l'original.

AC INPUT FUSES

Verify that the appropriate ac fuses are present.

In the ac distribution module, the input for each UPS module is protected by a 32A fuse for each phase, so that each module, including the controller, has 3 fuses (one each for the L1, L2, and L3 phases). Ten modules plus the controller would require 33 fuses, as illustrated in Figure 30. In the 100 kVA model the fuse receptacles are numbered from right to left.

AC FUSES																				
Floor 1			Floor 2			Floor 3			Floor 4			Floor 5			Floor 6			Floor 7		
L1	L2	L3	L1	L2	L3	L1	L2	L3	L1	L2	L3	L1	L2	L3	L1	L2	L3	L1	L2	L3
○	○	○	○	○	○	○	○	○	○	○	○	○	○	○	○	○	○	○	○	○
○	○	○	○	○	○	○	○	○	○	○	○	○	○	○	○	○	○	○	○	○
Floor 8			Floor 9			Floor 10			Floor 11											
L1	L2	L3	L1	L2	L3	L1	L2	L3	L1	L2	L3									
○	○	○	○	○	○	○	○	○	○	○	○									
○	○	○	○	○	○	○	○	○	○	○	○									

Figure 30: Ac input fuses (100 kVA model)

DC DISTRIBUTION FUSES

Verify that the appropriate dc fuses are present.

All dc fuses are located on the opposite side (the front side) of the dc distribution panel. There are two fuses for each power module and for the controller – one for the positive line and one for the negative line. Figure 31 shows the fuse assignments for the 100 kVA model.

DC FUSES																					
Floor 1		Floor 2		Floor 3		Floor 4		Floor 5		Floor 6		Floor 7		Floor 8		Floor 9		Floor 10		Floor 11	
○	○	○	○	○	○	○	○	○	○	○	○	○	○	○	○	○	○	○	○	○	○
○	○	○	○	○	○	○	○	○	○	○	○	○	○	○	○	○	○	○	○	○	○

Figure 31: Dc distribution fuse assignment (100 kVA)

5.6 Special terminal connections

This section describes the special-purpose terminal connections of the POWER+.

The special-purpose terminal connections on the 100 kVA model are on the rear side of the UPS near the power terminals and can be seen in Figure 19 on page 23. Figure 32 shows the connections to external devices.

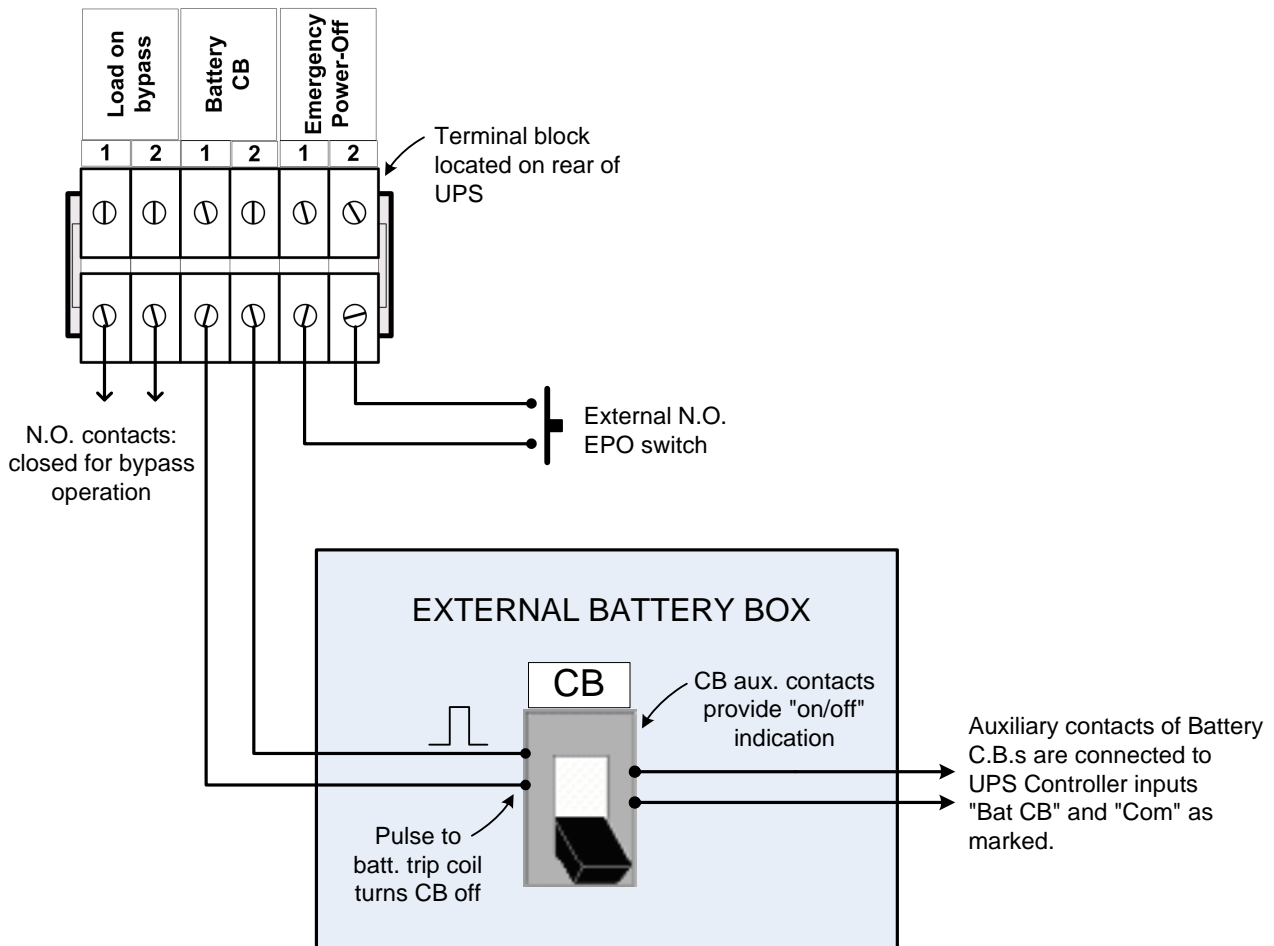

Figure 32: Special purpose terminal connections

There are also some special purpose connections on the rear of the controller module.

5.6.1 Load on bypass alarm

This output dry contact is Normally Open, and closes when the UPS transfers the load to bypass. The dry contact reopens again when the UPS returns to inverter mode.

5.6.2 Battery trip coil

The battery trip coil terminals are intended to be connected to the trip coil of the battery circuit breaker. If this is done and the EPO switch is activated, the POWER+ sends a pulse of 120 V to the battery circuit breaker trip coil, causing the battery circuit breaker to turn OFF.

Use of the battery trip coil means that not only will use of the EPO switch cut all ac output from the UPS, it will also turn off the battery circuit breaker.

5.6.3 Emergency power-off

An external Emergency Power-Off (EPO) switch can be installed by the customer to enable immediate shutdown of the UPS. Once switched off by the EPO, the POWER+ must be restarted manually.

The UPS has two terminals marked "EPO" for connection of an EPO switch (Figure 32). Use of a large mushroom-type N.O. (normally open) pushbutton rated for not less than 1 A / 24 Vdc is recommended. Verify continuity of the switch at its connection points before installing.

In the event that the POWER+ UPS is used in a computer room, installation of the EPO switch is mandatory. It is also **required** in this case that activating the EPO switch should disconnect the dc power supply from the batteries. The battery CB terminals on the POWER+ (Figure 19) must be connected to the trip coil terminals on the battery cabinet (Figure 32).

To restart the UPS following use of the EPO, turn off all input circuit breakers (rectifier ac input, bypass ac input, battery) and then start the POWER+ as normal (see section 6 on page 57).

5.7 Dry Contacts

On the uppermost green plug of the Controller module, on the right side of the plug, there are four alarm contacts. We describe them here, in right-to-left order.

														4	3	2	1
COM	IN 3	+ 3	- 3	COM	IN 2	+ 2	- 2	COM	IN 1	+ 1	- 1			N.C 2	N.C 1	BAT. C.B	COM
DC CURRENT MEASURE												INPUTS					

Figure 33: Dry contacts on rear of controller

1. The first contact on the right is COM. It is used with several of the other contacts.
2. The second contact from the right informs on the status of the BATTERY circuit breaker. This contact is used together with the first COM contact. This contact is normally closed.

When the BATTERY circuit breaker is turned off (opened), the contact opens, and an alarm is generated.

The alarm is shown in the log display as “BATT CB”, and is number 25 in the Power+’s list of alarms.

If this optional feature has been ordered, then in the factory, two BATT CB dry contacts are connected to the two special-purpose terminals labeled "Bat. CB".

To make use of this BATT CB alarm, the customer must connect the two special purpose terminals labeled "Bat. CB" to the auxiliary contacts of the circuit breaker or switch of his battery cabinet. The auxiliary contacts on his battery cabinet switch must be Normally Closed.

3. Contact “NC1”, normally closed, is the third contact from the right on the green plug. This contact is used together with the first contact, COM, and reports the status of the lightning protection. When NC1 is closed, this means that the lightning protection is OK; when NC is open, the lightning protection is NOT OK.

When this contact opens, the event is listed in the alarm display as USER-1. This is alarm number 17 in Power+’s internal list of alarms.

4. The fourth contact from the right is NC2. NC2 is used with the first COM contact to report the status of the OUTPUT circuit breaker. When the OUTPUT circuit breaker is turned off (opened), the NC2 contact opens and an alarm is produced. The alarm appears in the system alarm display as USER-2.

5.8 Inspections to be performed prior to installation

Table 8: Pre-installation inspections

	TYPE OF CHECK		REQUIREMENT	VALUE / VERIFICATION
1.	Ambient temperature in the immediate location of the equipment		Recommended: between +59 ° F and +77 ° F (+15 °C and +25 °C)	
			Required: +14 to +104 ° F (-10 to +40 ° C) for 10 to 80 kVA, +14 to +86 ° F (-10 to +30 ° C) for 90 & 100 kVA.	
2.	Humidity and condensation		Verify that there is no water condensation or dampness within the installation site	
3.	Ventilation		Verify that sufficient airflow or forced ventilation is provided for battery cabinets location	
4.	Foundation and route to installation site		Verification of adequate structure, space and clearance for dimensions and weights of the UPS units and their battery cabinets	
5.	When planning the location of the UPS units, room for access to battery cabinets and electrical boards is critical.		Verify 36 in. (91 cm) clearance at rear for access to cable connections and fuses, and 39 in. (100 cm) clearance at front for user access and service.	
6.	Circuit breakers on the electrical board supplying the system		Must be in accordance with Gamatronic system specifications and connection schematic.	
7.	Diameter of input and output power cable connections, PE (Gnd) and neutral lines.		Must comply with local and international codes, and be appropriate for the circuit breakers protecting them. Refer to connections schematic.	
8.	Lightning / Voltage surge protection on electrical board supplying the system.		Voltage surge suppressors type B are recommended to be installed between each phase and the neutral line: Ratings: 150 Vac for 110-120 Vac mains.	
9.	Ac input voltage	3-3 configuration	Phase-to-Phase: 3x208* Vac, +15 %, -25 %	L1-L2 L2-L3 L3-L1
			Phase-to-Neutral: 120* Vac, +10 %, -15 %	L1 L2 L3
		2-2 configuration	Phase-to-Phase: 3x208* Vac Wye, +15 %, -25 %	L1-L2
			Phase-to-Neutral: 120* Vac, +10 %, -15 %	L1 L2
10.	Voltage between neutral and ground		0 – 2 Vac	
11.	System installation and start-up		Must be performed only by authorized personnel in accordance with connection schematic, Gamatronic system specifications and this User Guide.	

* Or other, according to nominal voltage rating of local power mains.

5.9 Installation Procedure

Table 9: Installation procedure

STEP	OPERATION
1	Remove rear covers and connect ac input and output power cables to terminals according to markings as shown in this User Guide and according to connection schematic. <u>Verify correct phase sequence</u> between board and UPS.
2	Consult the connection diagram - Figure 21 on page 25. See section 5.1 for recommended wire size and tightening torque. Connect ground lines to busses according to markings as shown in the connection diagram. Verify secure connections.
3	Connect the dc power cables of the battery cabinets to the UPS terminals according to markings as shown in the connection diagram (see step 2 above). Connect neutral and ground lines to busses as per the connection diagram. If the UPS is delivered without batteries, Gamatronic is not responsible for any damage or malfunction due to incorrect wiring of the batteries. <u>Verify correct polarity of the connections (+ / N / -)</u> Between the Battery Cabinets C.B.s / Terminals and the UPS terminals. Auxiliary contacts of Battery C.B.s are connected to UPS Controller inputs "Bat CB" and "Com" as marked.
4	If an external battery cabinet is being used, before turning on the battery cabinet circuit breaker perform the following two checks: Measure the voltage between the (+) and (-) terminals on the battery cabinet. The voltage must be within the range of 384–432 Vdc. If the voltage is not within this range, determine what the problem is and resolve it before continuing with system start-up. b.) On the battery cabinet, measure the voltage between the (+) terminal and the Neutral terminal, and between the (-) terminal and the Neutral terminal. Both measurements should be within the range of 196–216 Vdc. If a reading outside of that range is obtained, determine what the problem is and resolve it before continuing with system startup.
5	An external N.O. EPO switch may be connected according to Figure 32 on page 37. EPO wiring and switch rating must be rated for at least 1A / 24 Vdc.
6	Before connecting power to each system verify again that all connections are secure and are according to instructions and schematics.
7	Follow the instructions in section 5.10 "First-time Startup" which begins on page 42.

5.10 First-time Startup

This section describes the procedure for starting up the Power+ for the first time, after having completed the installation process described in the previous chapter.

1. Ensure that the maintenance bypass switch is set to NORMAL (OFF), and that no load devices are connected to the UPS.

Note: When applying power to the **POWER+**, the system automatically runs the startup process without a need to press the On/Off button.

2. Turn the ac input and ac bypass switch ON and wait (for about 2 minutes) for the **POWER+** to initialize.
3. The start-up sequence will begin and the control panel will show the following sequence. (The details of the display may vary from what is shown in the illustrations below, depending on your system's particulars.)

At start-up, the following screen sequence appears:

```

      UPS POWER+
      SC25270105
    W E L C O M E ! ! !
  
```

Figure 34: Start-up screen 1

```

      WARN I N G   ! ! !
      S Y S T E M   R U N N I N G   I N :
    S I L I C O N   M O D E   ( J P 2   -   I N )
    ----- P L E A S E   N O T I F Y   S U P E R V I S O R -----
  
```

Figure 35: Start-up screen 2

In "SILICON MODE", commands issued through the Power+ Control Panel are executed immediately. Operators should exercise caution.

Note: In Figure 35, "Silicon mode" indicates that the configuration jumper is installed, thus allowing for modifications.

```

    W A I T   F O R   R E S U L T S . . .
    S T A T I C   R A M :   P A S S E D   R . T   C L O C K :   P A S S E D
    E E P R O M   -   1 :   P A S S E D
    E E P R O M   -   3 :   P A S S E D   D C   S U P P L I E S :   P A S S E D
  
```

Figure 36: Start-up screen 3

```
S Y S T E M       I N I T I A L I Z I N G
                S C 2 5 2 7 0 1 0 5
PLEASE WAIT FOR COUNT DOWN TO FINISH
                4 5   S E C O N D S   L E F T
```

Figure 37: Start-up screen 4

During this step, the LEDs are also checked sequentially.

4. Finally, the normal default screen is displayed. Verify that the correct number of phases is displayed:
 - a. For 3-3 configuration, under the LOAD LEVEL heading, you should see a line for L1, L2, and L3 as in Figure 38.
 - b. For 2-2 configuration, you should lines for L1 and L2 only, as in Figure 39.

```
LOAD LEVEL                ---11: 20: 25---
L1: _____ 000A, 120V  BATTERY:  432V
L2: _____ 000A, 120V  UPS OK    (ON)
L3: _____ 000A, 120V  STSW OK   (INV)
```

Figure 38: Default screen, with no load, for 3-phase output

```
LOAD LEVEL                ---11: 20: 25---
L1: _____ 000A, 120V  BATTERY:  432V
L2: _____ 000A, 120V  UPS OK    (ON)
                               STSW OK   (INV)
```

Figure 39: Default screen, with no load, for 2-phase output

5. Switch all battery switches "ON" on all battery cabinets.
6. You can now turn on the load devices.
7. After turning on the load devices, verify that you have a normal reading on the display screen.
 - a. For 3-3 configuration, the display shows readings for L1, L2, and L3 as in Figure 40 below, but of course your readings will be different.
 - b. For 2-2 configuration, the display shows readings for L1 and L2 only, as in Figure 41.

LOAD LEVEL		---11: 20: 25---
L1: ●●●○○_____	030A, 120V	BATTERY: 432V
L2: ●●●○_____	024A, 120V	UPS OK (ON)
L3: ●●●_____	022A, 120V	STSW OK (INV)

Figure 40: Normal display, system under load (3-phase output)

LOAD LEVEL		---11: 20: 25---
L1: ●●●○○_____	030A, 120V	BATTERY: 432V
L2: ●●●○_____	024A, 120V	UPS OK (ON)
		STSW OK (INV)

Figure 41: Normal display, system under load (2-phase output)

IMPORTANT NOTE: YOUR POWER+ SYSTEM HAS BEEN DELIVERED TO YOU WITH THE OUTPUT VOLTAGE AND FREQUENCY SET TO MATCH YOUR REQUIREMENTS. CHECK NOW TO VERIFY THAT THESE SETTINGS ARE CORRECT.

TO SET MODULE/S FREQUENCY, SEE SECTION 8.9.2 ON PAGE 92.
 TO SET MODULE/S VOLTAGE, SEE SECTION 8.9.3 ON PAGE 93.

(If the voltage and frequency settings are correct, continue with section 5.11 below.)

5.11 Checks to be performed following initial startup

Table 10: Checks after initial startup

	TYPE OF CHECK	REQUIREMENT		RESULT
1.	Ac input voltage during operation under load. <u>Take measurements on the input terminals of the system</u>	Phase-to-phase: Not less than 2 % below no-load values measured in item 5 below.	3-3 configuration	L1-L2 L2-L3 L3-L1
			2-2 configuration	L1-L2
		Phase to Neutral: Not less than 2 % below no-load values measured in item 5 below.	3-3 configuration	L1 L2 L3
			2-2 configuration	L1 L2
2.	With no load on the system, measure current circulation between the units.	I _{rst} should be <10 A		
3.	With no load on the system, measure the dc voltage of the system.	Total dc voltage between + and – terminals should be between 384 V and 432 V.		(+) – (-)
4.	Voltage between neutral and ground during operation under load <u>On the input terminals of the system</u>	0–2 Vac		
5.	System output voltage	120 V +/- 2 % or other according to system specifications		
6.	Total system load / output current	Verify that the system is not overloaded in relation to system specifications		
7.	Correct and orderly operation	Verify that the UPS is operating normally in accordance with this User Guide and that no alarms or fault indications are evident		

NOTE: It is the responsibility of the customer to notify Gamatronic Electronic Industries Ltd. and receive approval for any deviations from these requirements.

TO COMPLETE THE INSTALLATION CHECKLIST, PLEASE SKETCH ON THE FOLLOWING PAGE A DIAGRAM OF YOUR SYSTEM'S CONNECTIONS, OR INCLUDE A FORMAL CONNECTION SCHEMATIC, AND FAX PAGES 40, 45, AND 46 TO GAMATRONIC.

5.12 Connection diagram

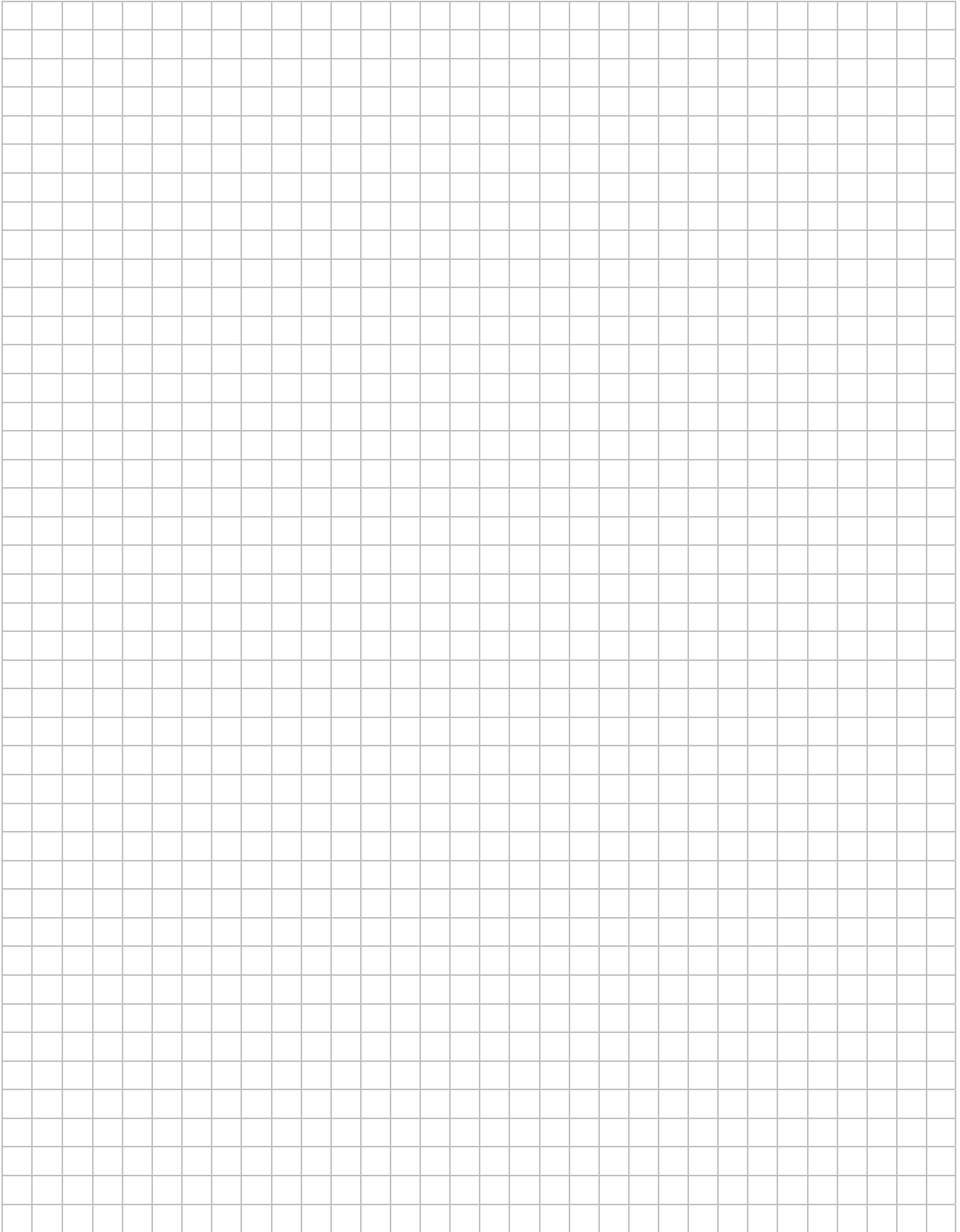

Figure 42: Connection diagram (for completion by the customer)

5.13 Configuration

Perform the following configuration steps from the Control Panel.

5.13.1 Check Configured Modules

Verify that the number of configured modules matches the desired output power, and verify that the number of redundant modules is correct. Modify as needed.

1. Press **Ent** to reach the Main Menu.

```
1> SYSTEM      4> HI STORY    7> SETUP
2> UPS MODULE  5> BATTERY    8> STATIC SW
3> SELFTEST    6> ALARM      9> _____
NAVIGATE: <UP, DOWN> 1 SELECT: <ENTER>
```

Figure 43: Main Menu

2. From the Main Menu select option 7, Setup.

[Main Menu > SETUP]

```
POWER+ System Setup
Type in Level -1 PASSWORD, THEN – ENTER
Your privilege will expire after 15 min.
PASSWORD: _____
```

Figure 44: Password access

3. When the Password access panel appears, enter the password and press **Ent**. The factory default password is to press the  key 8 times.

Note: If the password has been changed and the system does not accept it, request from your system administrator the technician password, which cannot be changed, and use it to reset the user password.

4. Select **Service**, option 8:

[Main Menu > SETUP > (password) > Ent]

```
1> Al arm set   5> Ti me      9> Si l i con
2> Modul e conf. 6> Si te
3> Battery     7> Password #1
4> Charge      8> Servi ce
```

Figure 45: Setup menu

5. Select **Configure**, option 5, to configure the Power+ modules:

[Main Menu > SETUP > (password) > Ent > Service]

```

1> ----- 4> DryOut Test 7> -----
2> UPSs    5> Configure  8> Powr. Calib
3> ----- 6> En/Di s shar 9> SC2012. .
Select, then Enter

```

Figure 46: Service menu

6. Select **# UPSs (total)**, option 2, to specify the total number of modules in the system:

[Main Menu > SETUP > (password) > Ent > Service > Configure]

```

1> # OF UPSs (redundancy) 5> Dry, Al arms
2> # OF UPSs (total)      6> Calibrati on
3> # OF BATT              7> Paral lel /StandAl one
4> Static Swi tch Setup   8> REM COMMAND

```

Figure 47: Configure menu

7. Use the arrow keys to specify the total number of modules installed in the Power+, and then press **Ent**:

[Main Menu > SETUP > (password) > Ent > Service > Configure > # OF UPSs (total)]

Set number of UPSs (total)

04 (02 redundant)

Figure 48: # of UPSs (Total)

8. Select 1, **# of UPSs (Redundancy)** in Figure 47 to specify the number of modules used for redundancy:

[Main Menu > SETUP > (password) > Ent > Service > Configure > # OF UPSs (redundancy)]

Set number of UPSs (Redundancy)

01 (04 total)

Figure 49: # of UPSs (Redundancy)

Note: The redundant modules are designated to replace other system modules when they stop working. For example, a 100 kVA system with 10 modules of which 2 are configured for redundancy can deliver a maximum of 80 kVA.

5.13.2 Check Total Ampere-Hours

This procedure is designed to ensure that the total capacity of the batteries attached to Power+ matches the definition of the total capacity in the System Controller.

1. Check the total capacity of the installed batteries attached to Power+.
2. Verify that the same value is specified in the System Controller. If not, modify the definition in the System Controller to match the capacity of the installed batteries.

To check the capacity defined in the System Controller:

1. From the Main Menu select option 5, **Battery**.

[Main Menu > BATTERY]

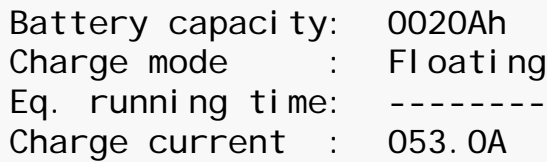

Battery capacity: 0020Ah
Charge mode : Floating
Eq. running time: -----
Charge current : 053.0A

Figure 50: Battery status

The battery status panel displays the battery capacity defined in the System Controller.

To set the battery capacity in the System Controller to a different value:

1. Note the current value of battery capacity:

[Main Menu > BATTERY > ▼ > ▼ > ▼ > ▼ > ▼]

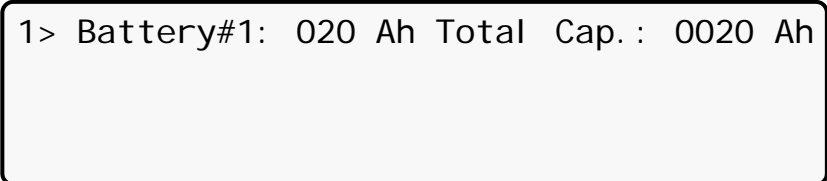

1> Battery#1: 020 Ah Total Cap. : 0020 Ah

Figure 51: Battery capacity

2. Adjust the battery capacity to correspond to that of the attached batteries, and press **Ent**:

[Main Menu > SETUP > (password) > Battery > Capacity 0020AH) > Set Capacity of Battery #1]

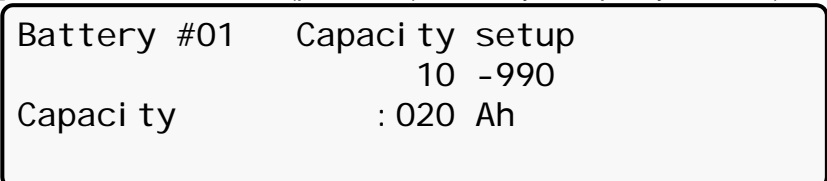





Battery #01 Capacity setup
10 -990
Capacity : 020 Ah

Figure 52: Set battery capacity

3. Repeat step 1 above to verify the set battery capacity.

5.13.3 Set Date and Time and Serial Number

To verify the date and time set in the System Controller and make sure that they are correct:

1. Use the  and  keys to select the year, month, day, hour, minute, or second you wish to modify, then use the  and  keys to set the correct value for the selected item. Press **Ent**:

[Main Menu > SETUP > (password) > Time]

Set real time					
Year	Month	Day	Hour	Min	Sec
2011	09	30	23	58	00

Figure 53: Date and time

2. Enter the serial number of the Power+ system in the System Controller, and then press **Ent**:

[Main Menu > SETUP > (password) > Site]

Site number: 013271

Figure 54: Site number

Note: The serial number of Power+ is on a bar-code label at the bottom of the unit, on the left hand side.

5.13.4 Define the IP Address of the Power+

This procedure assigns the Power+ an address within the domain of the customer's computer network.

1. Obtain IP, gateway, and mask addresses from the system administrator of the organization for the Power+ system.
2. Select **Set IP ADDRESS** in the Network menu:

[Main Menu > SETUP > (password) > Ent > Service > SC2012 > Network]

1> Set IP ADDRESS	157. 211. 000. 253
2> Set GATEWAY	157. 211. 000. 251
3> Set MASK	255. 255. 255. 000
4> Store	5> SNMP factor Select: 1

Figure 55: Network menu

3. Use the arrow keys to set the IP address, and then press **Ent**:

[Main Menu > SETUP > (password) > Ent > Service > SC2012 > Network > Set IP ADDRESS]

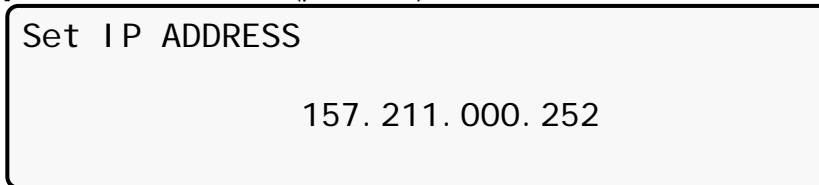

Set IP ADDRESS

157.211.000.252

Figure 56: IP Address

4. Use the arrows keys to set the gateway and press **Ent**:

[Main Menu > SETUP > (password) > Ent > Service > SC2012 > Network > Set GATEWAY]

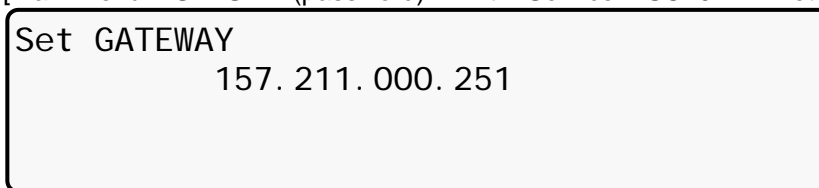

Set GATEWAY

157.211.000.251

Figure 57: Gateway

5. Select **Store**:

[Main Menu > SETUP > (password) > Ent > Service > SC2012 > Network]

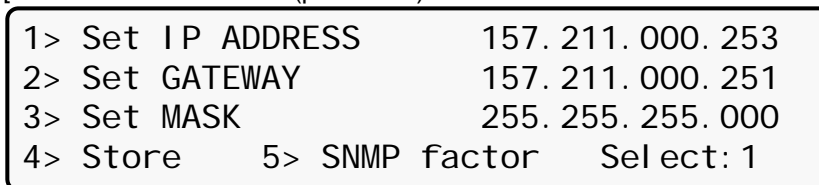

1> Set IP ADDRESS	157.211.000.253
2> Set GATEWAY	157.211.000.251
3> Set MASK	255.255.255.000
4> Store	5> SNMP factor Select: 1

Figure 58: Network menu

Entered information is now stored in the controller.

5.14 Testing

Perform the following tests on the Power+ unit.

5.14.1 Blackout Test

This test is designed to verify the operation of Power+ in the event of a blackout, when no ac power is supplied to the UPS.

1. Turn all ac input to the system Off (turn Off ac input switches to both Bypass and Rectifier).
2. Measure the phase-to-neutral voltage for each output phase. The measurements should all be 120 V (or as specified).

5.14.2 Cold Start

This test is designed to verify the operation of the UPS after all input power (both mains and battery) has been shut off and the UPS is powered up with battery only and no ac input.

1. Turn all ac and dc input to the system Off, so that there are no voltages at any of the inputs to the UPS.
2. Turn On the switch to the dc input (from the batteries) only.
3. Wait approximately 2 minutes for Power+ to initialize (see Section 5.10, **First-time Startup**).
4. Measure the phase-to-neutral voltage for each output phase. The measurements should all be 120 V (or as specified).
5. Turn On the ac inputs to the system.

5.14.3 Test Under Load

This test is designed to verify the operation of Power+ under load.

1. Connect the load.
2. Measure the ac input voltage during operation under load. Take the measurements at the output terminals of Power+ (phase-to-phase between L1-L2, L2-L3, and L3-L1 and phase-to-neutral at L1, L2, and L3). Phase-to-phase and phase-to neutral voltage should be not less than 2% below no-load values.
3. Check and record the total system load (output current) and make sure that Power+ is not overloaded with respect to system specifications.
4. Ascertain correct and orderly operation. Verify that Power+ is operating normally and that no alarms or fault indications are present.

5.14.4 Check IP Communication with Controller

This test is designed to verify that the System Controller is properly configured for communication and that the Web server built-in into the System Controller is functioning properly.

1. Use an RJ45-to-RJ45 crossed cable to attach a laptop computer to the Ethernet (RJ45) port on the rear panel of the System Controller.
2. Configure the Network Connections of the laptop computer to make sure the computer is in the same domain as the UPS. (**Note:** the details of the following configuration procedure are for the Windows XP operating system. The configuration procedure will differ for other operating systems.)
 - a. Right click on the My Network Places icon on your desktop and select Properties.



Figure 59: Network Connections screen

- b. When the Network Connections screen appears, right-click on **Local Area Connection** and select **Properties**.

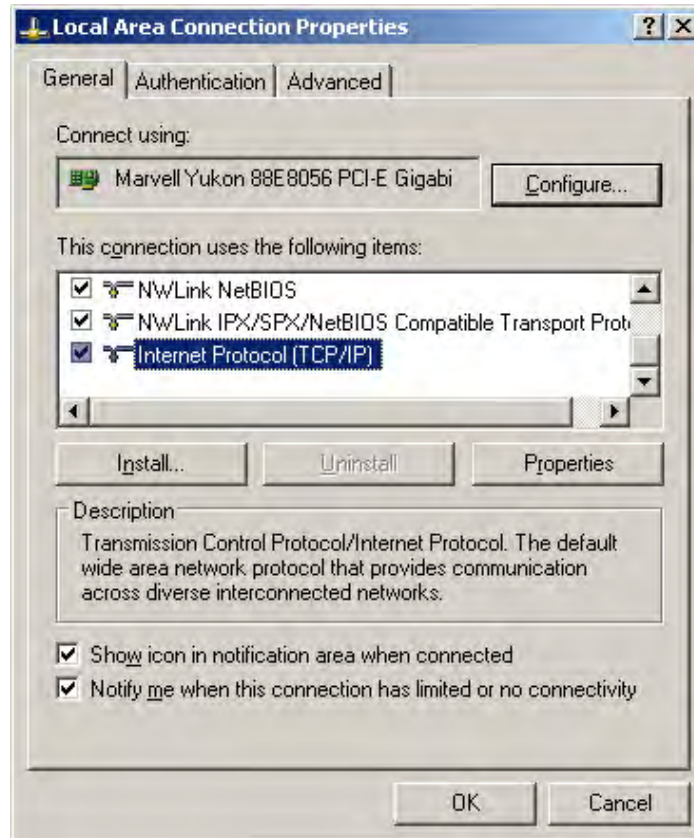

Figure 60: Local Area Connection Properties screen

- c. When the Local Area Connection Properties screen appears, in the **This connection uses the following items** window scroll down to **Internet Protocol (TCP/IP)** and double click on it.

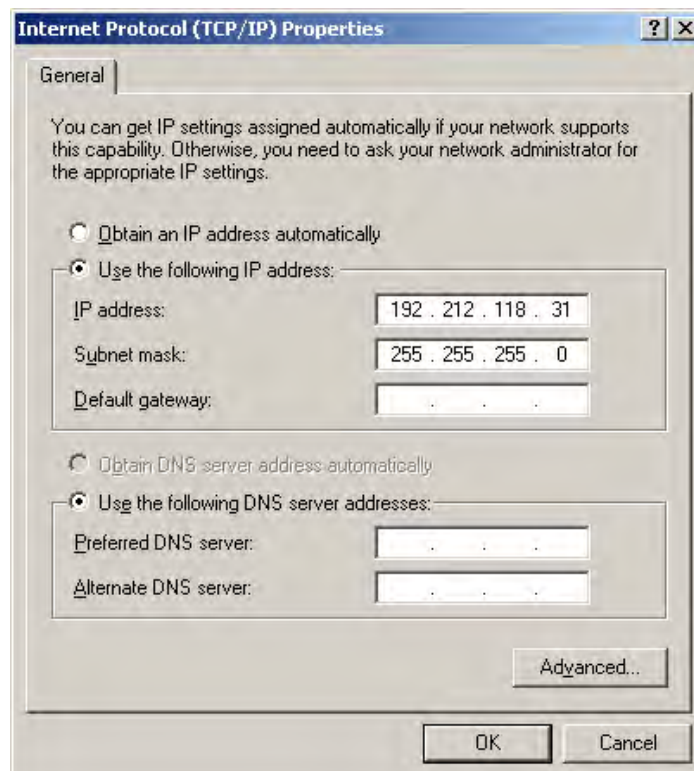

Figure 61: Internet Protocol (TCP/IP) Properties screen

- d. When the Internet Protocol (TCP/IP Properties) screen appears, click the **Use the following IP address** button and enter **IP address** and **Subnet mask** in the appropriate fields. Leave **Default gateway** blank. Make sure that the first three groups of numbers in the IP address (192.212.118 in the above example) are the same as those of the domain in which the UPS is installed, and that the last number (31 in the above example) is different (it can be any number from 0 to 255, other than the one already assigned to the UPS).
 - e. Click **OK** twice to complete the network connection.
3. Open your browser on the laptop computer and enter the IP address of the System Controller in the browser's address field to verify that you can reach the Web server on the System Controller. The system displays the main GMAci screen, similar to the one shown below.

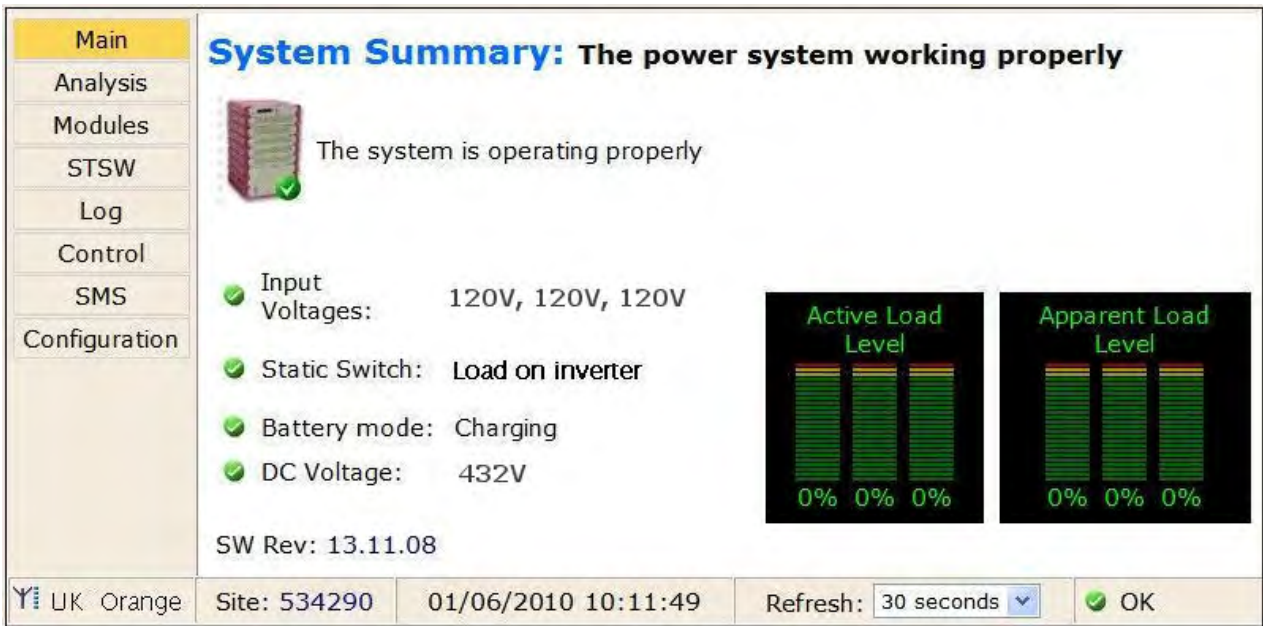

Figure 62: Main Screen of built-in web server

5.14.5 Test Wing Option

If Wing has been installed in the UPS, this test is designed to check that it is working properly by sending an SMS message through the Web interface of Wing to a specified phone number.

1. Click the **Send SMS** button on the left sidebar of the Main Screen of the built-in web server.



Figure 63: Login screen of built-in web server

2. When the login screen appears, enter *admin* for both **User name** and **Password**, and click **OK**.



Figure 64: SMS screen

3. A record of messages transmitted and received by the controller are recorded.

Note: Only the controller can send SMS messages or alarms.

6. POWER+ ROUTINE START-UP

6.1 Start-up after Shutdown

This section describes the start-up procedures for the operator after a **POWER+** shutdown. After shutdown, the **UPS on**, **Alarm** and **Load** indicators will flash.

After a normal **POWER+** shutdown the display screen indicates a load of zero amps, the UPS status is "OK, OFF"; the Static Switch status is "OK, BYP".

LOAD LEVEL		---	22: 21: 18---
L1: _____	000A, 120V	BATTERY:	432V
L2: _____	000A, 120V	UPS OK	(OFF)
L3: _____	000A, 120V	STSW OK	(BYP)

Figure 65: Main screen after a power shutdown

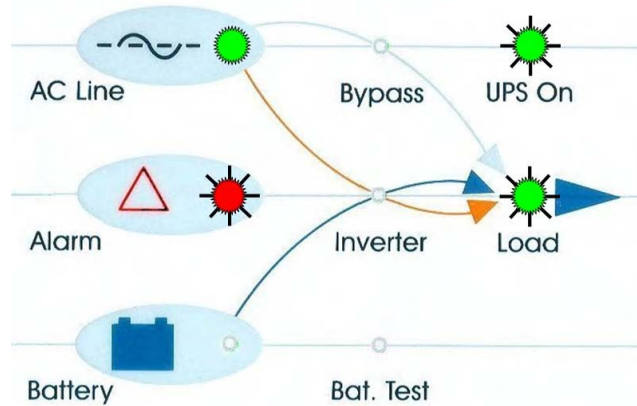

Figure 66: Main screen after a power shutdown indication

1. Press twice on the On/Off button on the upper right of the system controller panel.

Wait about 2 minutes for the **POWER+** to start up.

The following screen is displayed:

LOAD LEVEL		---	22: 21: 18---
L1: _____	000A, 120V	BATTERY:	432V
L2: _____	000A, 120V	UPS OK	(ON)
L3: _____	000A, 120V	STSW OK	(INV)

← Status indications

Figure 67: Main screen at power-up

Observe that UPS OK indication is now ON and the STSW OK now indicates INV.

If the display continues to indicate BYP, check on the Static Switch panel, that the inverter is running.

If the inverter indicator on the Static Switch panel is OFF:

- Press the Inv/Byp button on the static switch panel to switch the inverter ON and wait for the indicator to light.
- Press the Inv/Byp button on the lower right of the control panel.

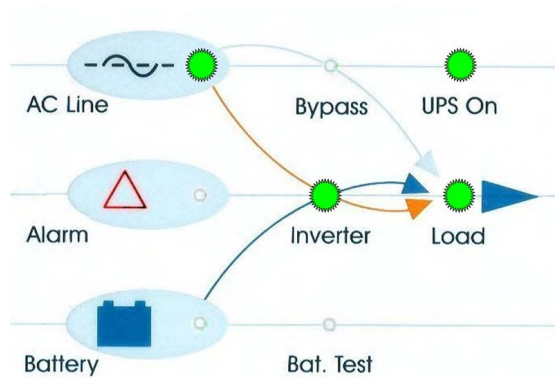

Figure 68: Normal operation indication

2. Connect the load and observe the results on the display.

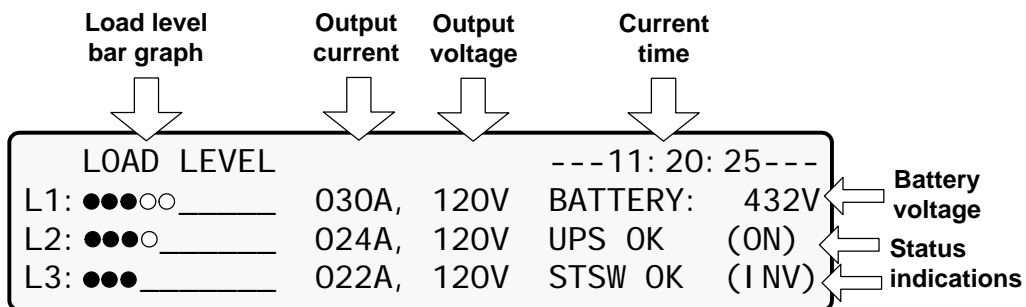

Figure 69: Main screen results

3. Observe that the “dot” bar graph now indicates the load presence and relative power consumption. The number of black dots represents kW, and the number of black and white dots together represents apparent power in kVA.

POWER+ start-up is now complete.

6.2 POWER+ Shutdown (Switching to Bypass)

1. Switch the load OFF.
2. Press twice on the On/Off button.
3. Wait 2 minutes for the **POWER+** to shut down. The control screen will indicate UPS OK (OFF).

LOAD LEVEL		---	22: 21: 18---
L1: _____	000A, 120V	BATTERY:	432V
L2: _____	000A, 120V	UPS OK	(OFF)
L3: _____	000A, 120V	STSW OK	(BYP)

Figure 70: Main screen – switching to bypass

Note: This does NOT switch the entire **POWER+** OFF. Power is still delivered to the load but in bypass.

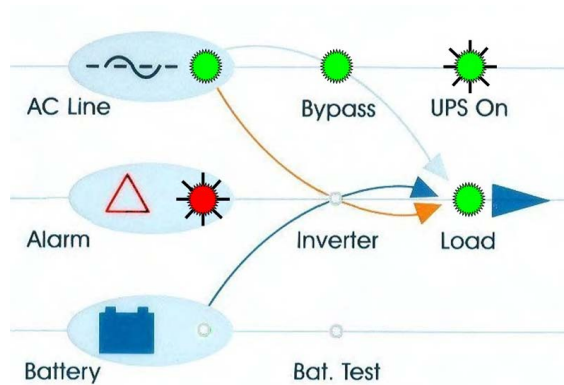

Figure 71: Bypass indication

6.3 POWER+ Total Shutdown (No Ac Output)

4. Switch the load OFF.
5. Press and hold the On/Off button for 10 seconds.
6. The control screen will indicate UPS OK (OFF).

LOAD LEVEL		---	23: 14: 40---
L1: _____	000A, 120V	BATTERY:	432V
L2: _____	000A, 120V	UPS OK	(OFF)
L3: _____	000A, 120V	STSW Warni ng !	

Figure 72: Main screen – total shutdown

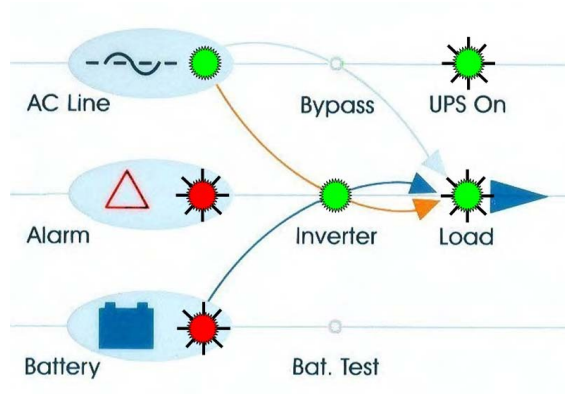

Figure 73: UPS off indication

7. **POWER+** CONTROL PANEL

The **POWER+** system is equipped with an LCM (Liquid Crystal Monitor) and touch pad control panel that enables the user to effectively manage the UPS system. Once **POWER+** is installed, the control panel serves as the user's primary interface with the system. Messages, warnings, and error conditions are relayed to the user through the display, LEDs and audible alarms.

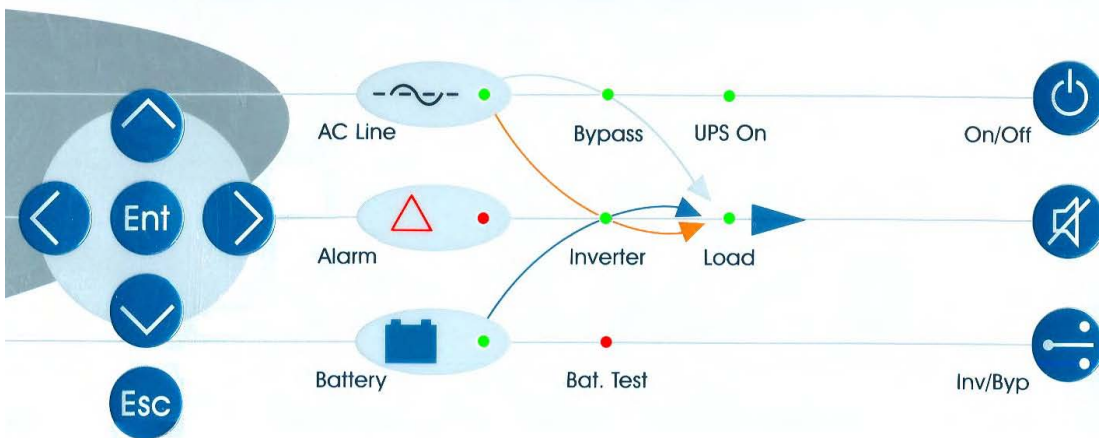

Figure 74: Control panel

The remainder of the current chapter contains a quick-reference summary of the functions available through the **POWER+** control menus.

Chapter 8, Power+ menu functions in detail, beginning on page 67 illustrates in detail the functions available through the **POWER+ control menus.**

7.1 Quick-reference summary of Power+ menu functions

The following flowcharts detail the structure of the PowerPlus menus.

The symbol **X.Y** directs you to a following chart. For example, **M.7.3** means "go to the diagram labeled M.7.3. Diagram M.7.3 illustrates sub-option 3 of Main Menu option 7.

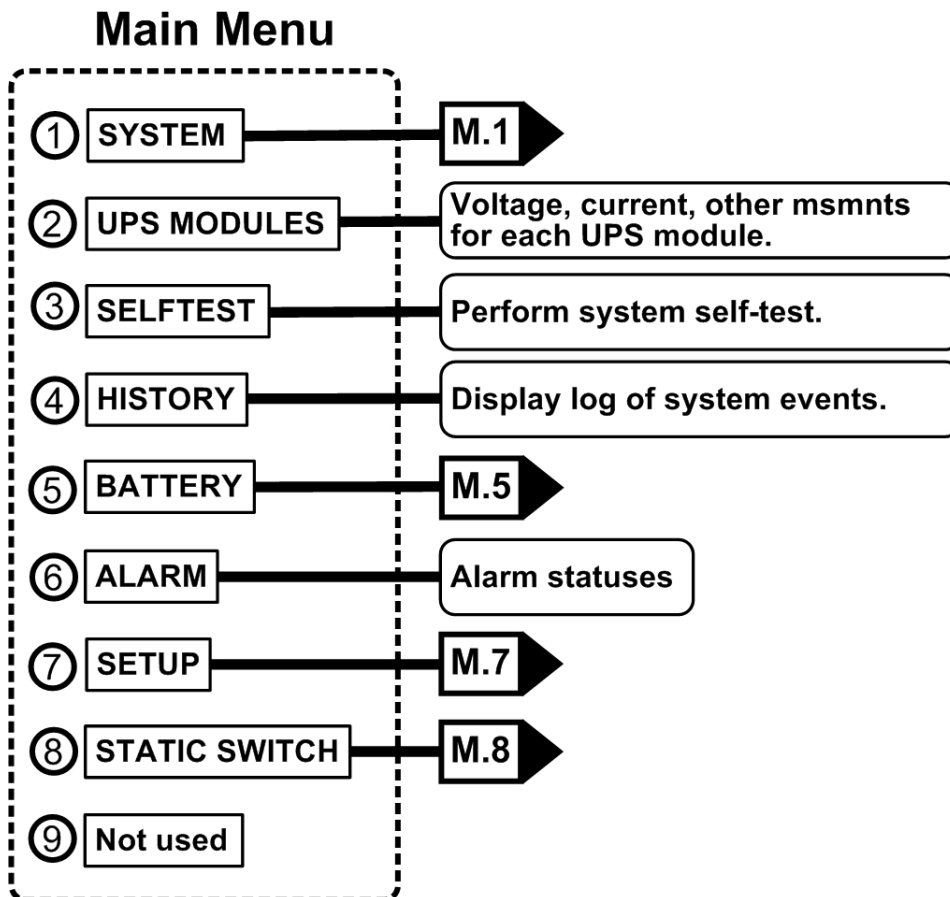

Figure 75: Main menu

Main Menu option 1, the "System" screen. Press the "up" or "down" keys to display various measurements.

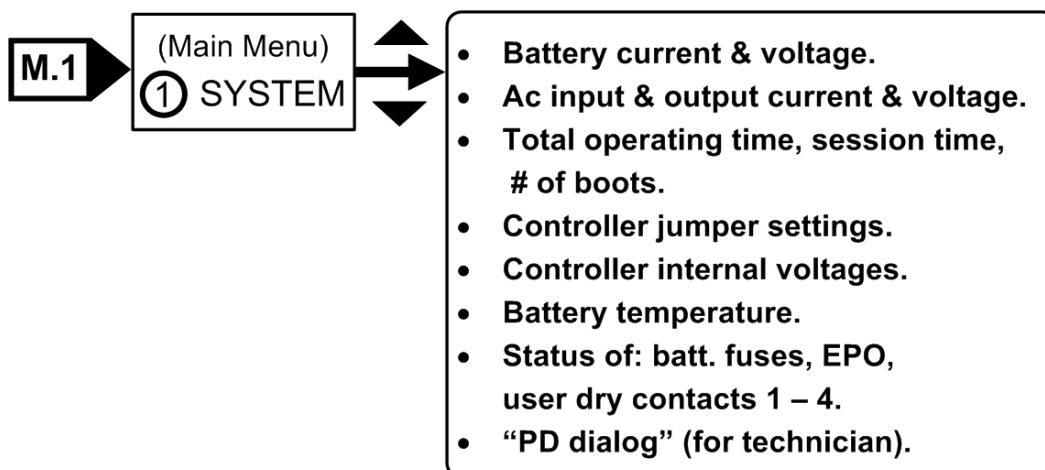

Figure 76: System menu

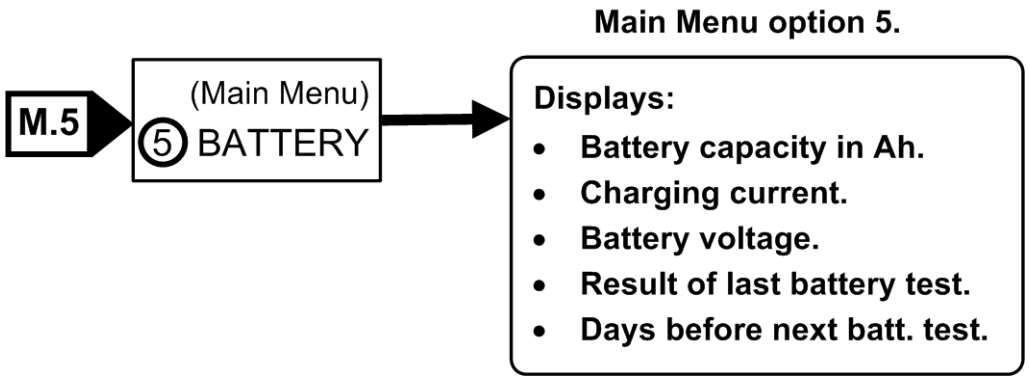

Figure 77: Battery menu

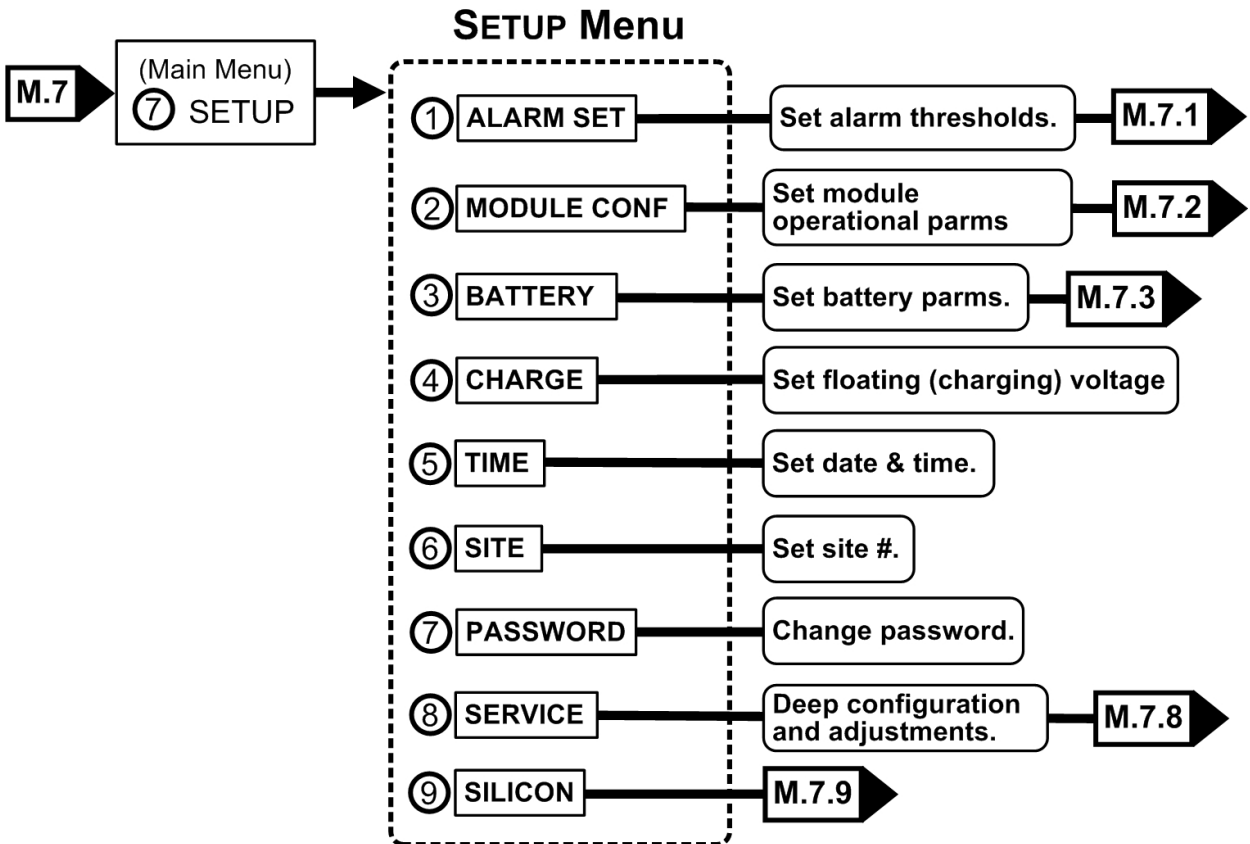

Figure 78: Setup menu

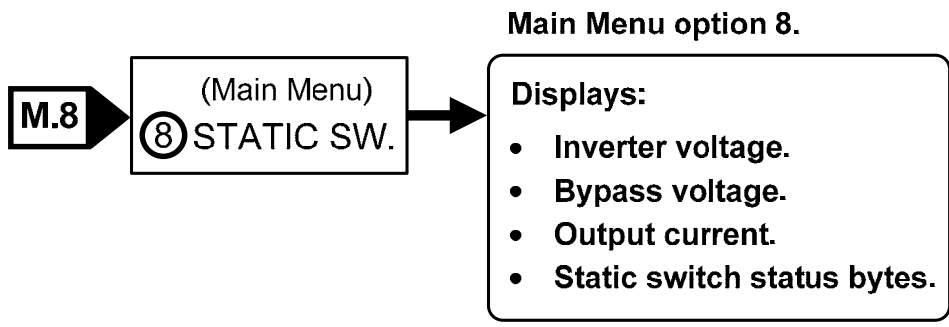

Figure 79: Static switch menu

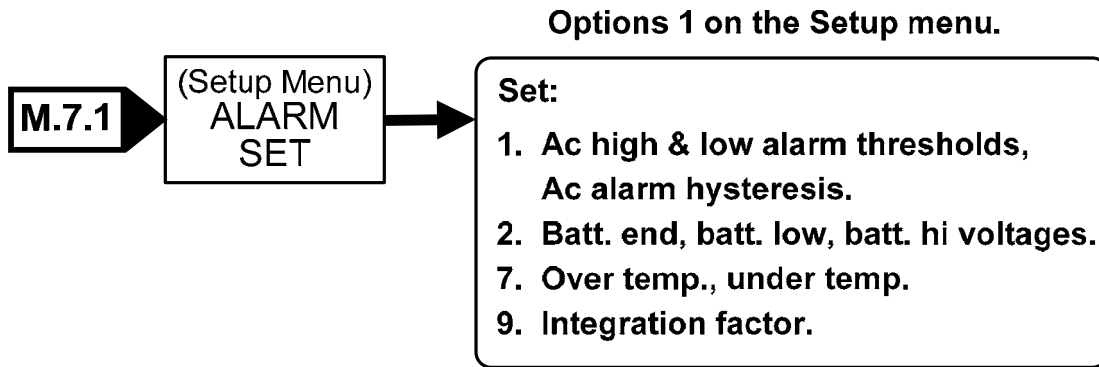

Figure 80: Alarm set sub-menu

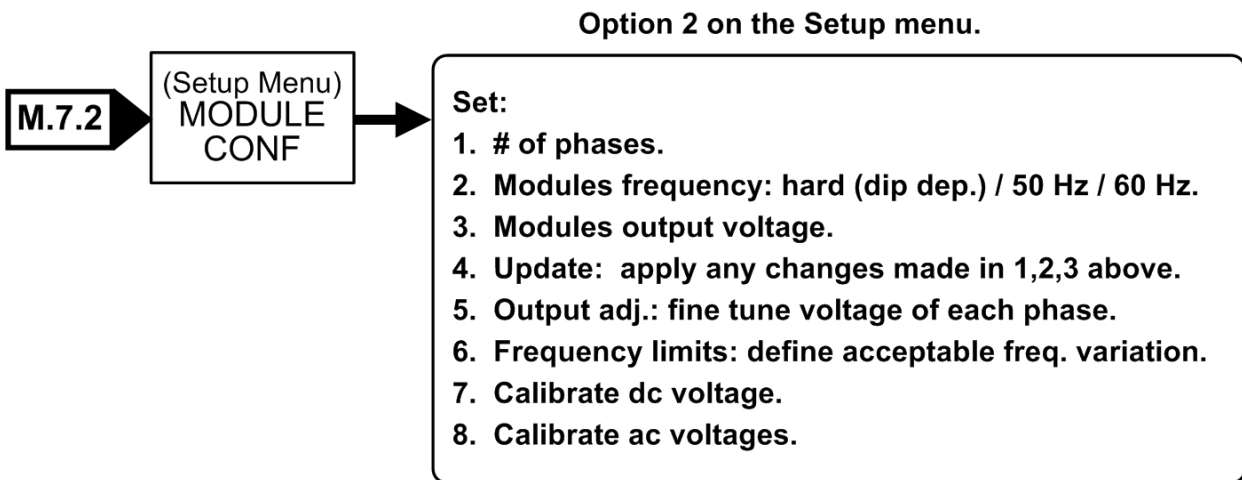

Figure 81: Module configuration sub-menu

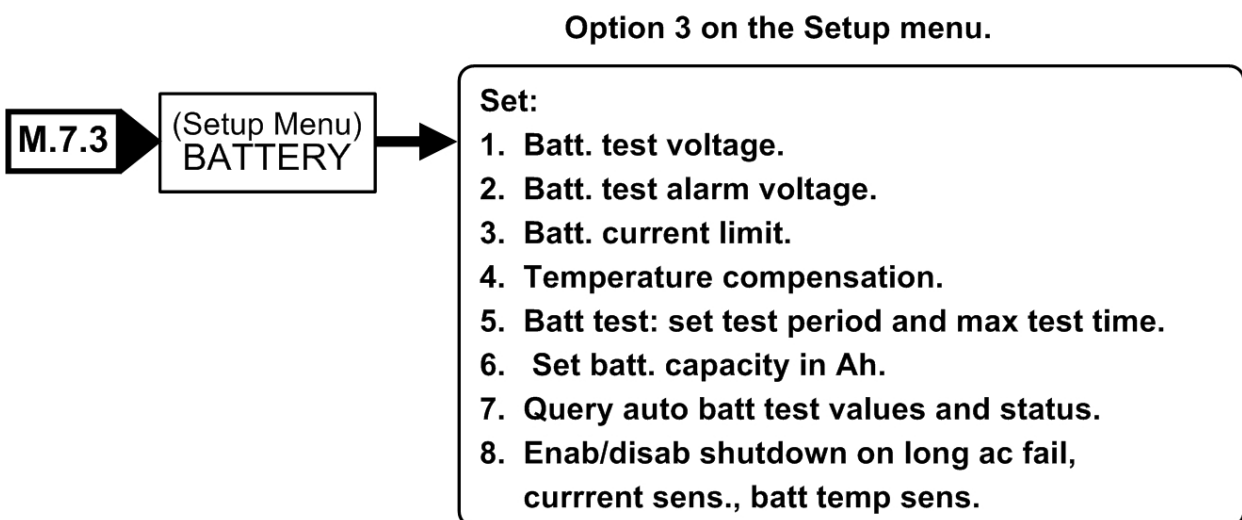

Figure 82: Battery menu

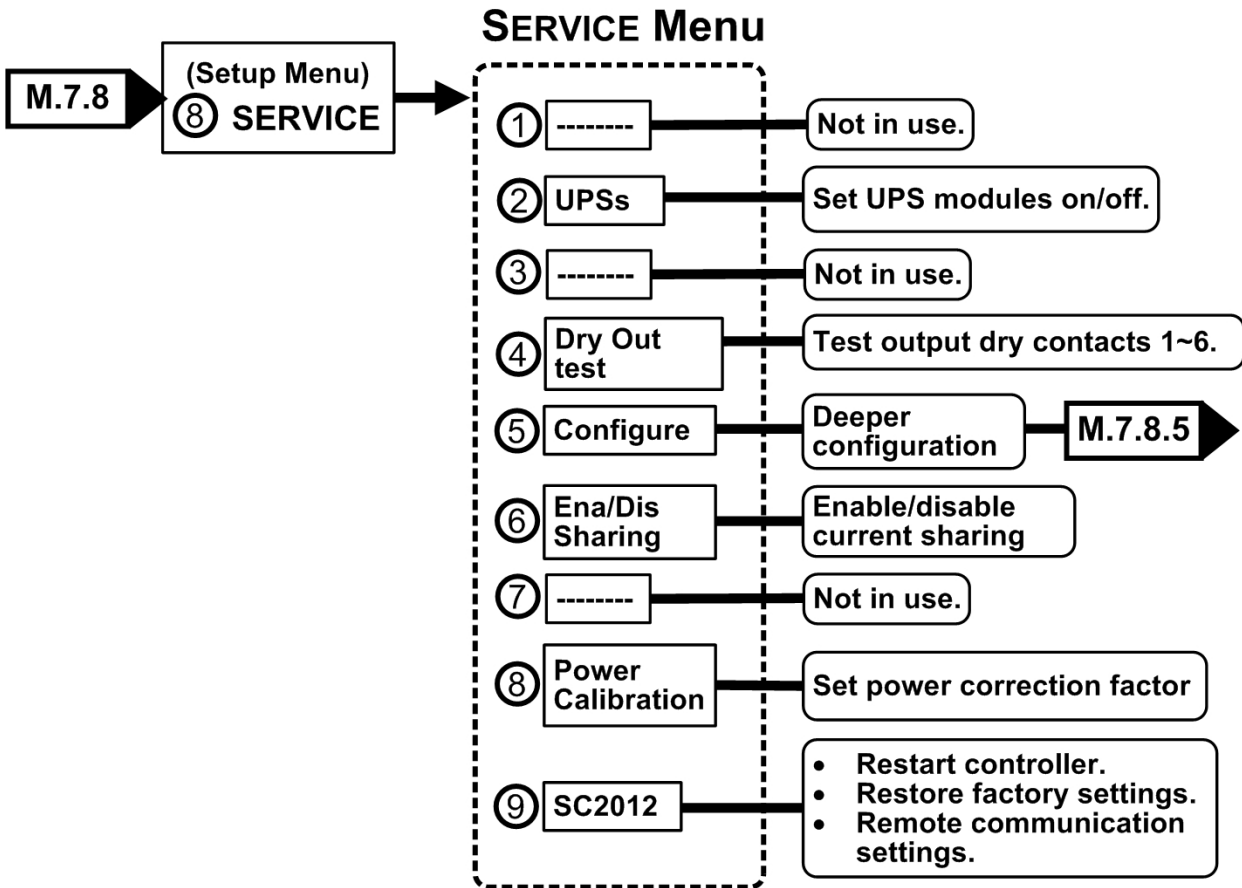

Figure 83: Service sub-menu

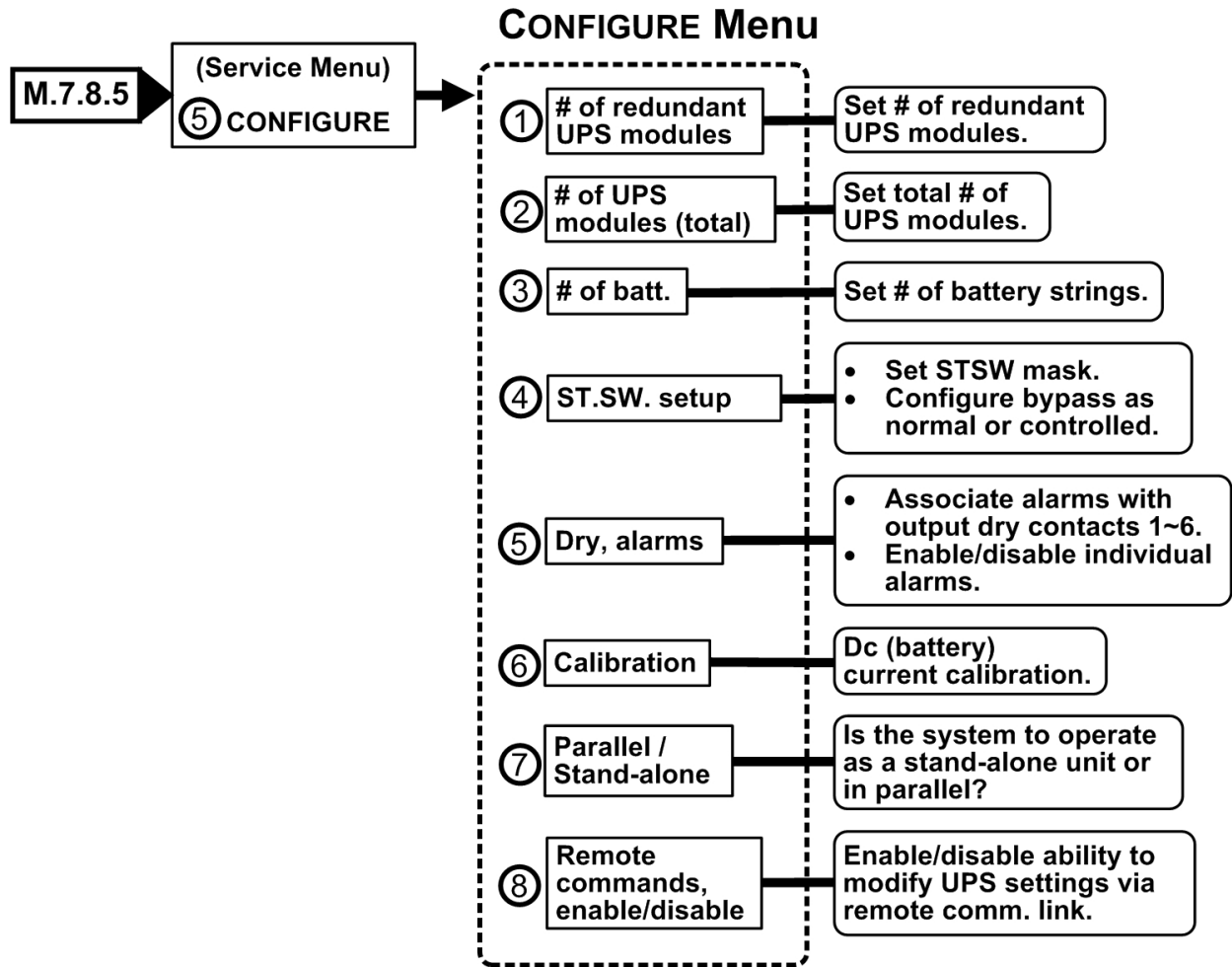

Figure 84: Configure sub-sub-menu

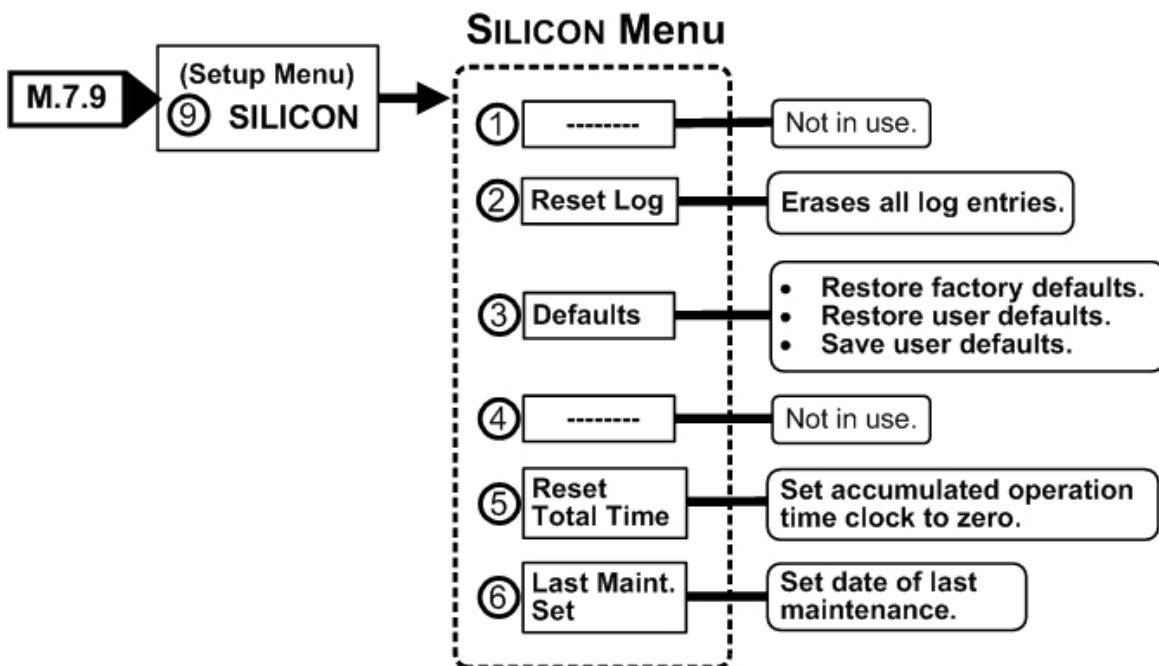

Figure 85: Silicon sub-menu

8. POWER+ MENU FUNCTIONS IN DETAIL

This chapter describes the functions available through the **POWER+** Main Menu and its submenus.

Note: If you are viewing this file in PDF format, it is possible to search for text in the displayed screens. This eases finding the desired screen.

8.1 Main Menu

Press the Enter button (**Ent**) to display the main menu.

Note: To return to the main menu at any time, press the Escape button (**Esc**) and then **Ent**.

1> SYSTEM	4> HISTORY	7> SETUP
2> UPS MODULE	5> BATTERY	8> STATIC SW
3> SELFTEST	6> ALARM	9> _____
NAVI GATE: <UP, DOWN> 1 SELECT: <ENTER>		

Figure 86: Main menu

Table 11: Main Menu Options

1>	SYSTEM	General information such as voltages, currents etc.
2>	UPS MODULE	Information for a specific UPS module
3>	SELFTEST	Self checking of the Controller's components (supply, RTC, memory)
4>	HISTORY	History log events (last 255 events, dated and timed)
5>	BATTERY	Charging / discharging voltages and currents, battery test etc.
6>	ALARM	Detailed alarm status
7>	SETUP	Configuring the system (number of modules, alarm, time etc.)
8>	STATIC SW	Static Switch data

8.2 "System" Option

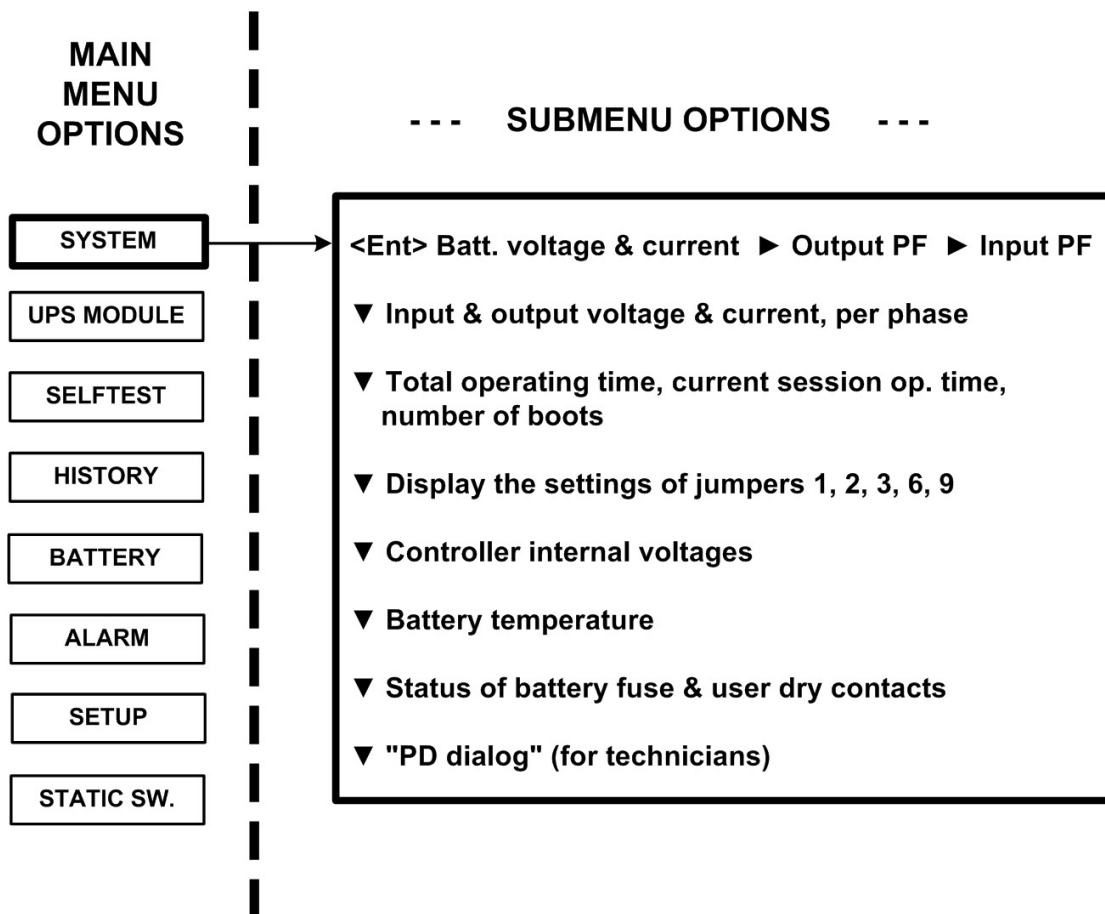

Figure 87: Main menu option 1 ("System")

1. The SYSTEM option (option 1) shows the dc voltages and current (positive, negative and summary):

[Main Menu > SYSTEM]

```
BATT CURR: -----> TOTAL +053.0A
BATT POS. : 216V   BATT +053.2A (0531)
BATT NEG. : 216V
BATT VOLT: 432V
```

Figure 88: System dc voltages

- View the current output power factors²:

[Main Menu > SYSTEM > ►]

OUTPUT	L1	L2	L3	TOTAL
KVA	000.4	000.2	000.2	000.8
KW	000.0	000.0	000.0	000.0
P. F.	0.00	0.00	0.00	0.00

Figure 89: Output power factor 1

- View the current input power factor:

[Main Menu > SYSTEM > ► > ►]

INPUT	L1	L2	L3	TOTAL
KVA	001.5	001.5	001.5	004.5
KW	000.0	000.0	000.0	000.0
P. F.	1.00	1.00	1.00	0.00

Figure 90: Input power factor 1

- View the three-phase input and output total voltage and current:

[Main Menu > SYSTEM > ▼]

PHASE:	-L1--	-L2--	-L3--
IN:	121V/022.0A	119V/022.0A	120V/021.0A
OUT:	120V/021.0A	120V/021.0A	120V/021.0A
-----	TOTAL UPS	IN/OUT	MEASUREMENTS

Figure 91: Overall phase voltages/currents

- View the total time, current session time, and boots so far:

[Main Menu > SYSTEM > ▼ ▼]

TOTAL	TIME:	19771 HOURS
CURRENT SESS.:		13075 HOURS
BOOTS SO FAR:		00010 TIMES

Figure 92: Elapsed time

² 1KVA is 1000 VA. Apparent power is measured in VA which is a reactive (i.e. a mix of both capacitive and inductive) load's RMS voltage multiplied the RMS current. True power is VA multiplied by the power factor, and the power factor is the cosine of the phase angle between voltage and current. A reactive load that draws an apparent power of 1000 VA and has a 0.5 power factor is consuming 500 watts of power. If a device were purely inductive, it would have a power factor 0.

6. View the system jumper settings without remote panel:

[Main Menu > SYSTEM > ▼ ▼ ▼]

JMP:	JMP1, JMP2, JMP3, JMP6 and JMP9
●=I N	1. NOT HARD SI LI CON
○●○○●	2. SI LI CON MODE 6. NO RMT PAN.
12369	3. CAPACI TY LOW 9. AC: 120V

Figure 93: Jumper settings WITHOUT remote panel

7. View the system jumper settings with remote panel:

[Main Menu > SYSTEM > ▼ ▼ ▼]

JMP:	JMP1, JMP2, JMP3, JMP6 and JMP9
●=I N	1. NOT HARD SI LI CON
○●○○●	2. SI LI CON MODE 6. Remote pan.
12369	3. CAPACI TY LOW 9. AC: 120V

Figure 94: Jumper settings WITH remote panel

Note: In Figure 93 and Figure 94, “Silicon mode” indicates that the configuration jumper is installed, thus allowing for modifications. “Hard Silicon” indicates that the factory defaults hard reset jumper is installed. This is required only at the factory or whenever software reset fails. Refer to section 8.15.9.3 for a detailed description of jumpers.

8. View the internal controller voltages:

[Main Menu > SYSTEM > ▼ ▼ ▼ ▼]

5VDC :	5. 19V	CONTROLLER I NTERNAL
12VDC:	12. 01V	VOLTAGES
5VP :	GOOD	
5V2 :	GOOD	-12VDC: GOOD

Figure 95: Internal controller voltages

9. View battery parameters:

[Main Menu > SYSTEM > ▼ ▼ ▼ ▼ ▼]

BATTERY CHARGE LEVEL:	010Ah	050%
WHILE TOTAL CAPACITY:	020Ah	
REMAI NI NG BACKUP:	0010	MI NUTES
BATTERY TEMPERATURE:	12°C	

Figure 96: Battery parameters

Note: The data displayed in Figure 96 depends on the options installed and configured. See Figure 162 on page 96 and Figure 198 on page 107.

10. View status of the fuses:

```
[Main Menu > SYSTEM > ▼ ▼ ▼ ▼ ▼ ▼ ▼ ▼]
BATT FUSE:  BAD      EMERGENCY:  OPEN
USER-1:     OPEN     USER-4:    OPEN
USER-2:     OPEN     7:         OPEN
USER-3:     OPEN     8:         OPEN
```

Figure 97: Fuse status

11. View communication with the converter in the transmit mode (for Technicians):

```
[Main Menu > SYSTEM > ▼ ▼ ▼ ▼ ▼ ▼ ▼ ▼]
PD DIALOG:  UPS    #01
T>c0 42 00 00 d8 00 00 00 00 00 00 00 00
00 00 00 00 00 00 aa
```

Figure 98: Communication with inverter – transmit

12. View communication with the converter in the receive mode (for Technicians):

```
[Main Menu > SYSTEM > ▼ ▼ ▼ ▼ ▼ ▼ ▼ ▼ ▶]
R<e0e0 0900 0003 0003 0003 e874 1074
1074 2f37 5362 0000 0200 0100 0310
f077 0000 0000 0000 0000 0000 0000
0000 0000 0000 0000 52 52
```

Figure 99: Communication with inverter – receive

13. Press **Ent** to return to the Main Menu (Figure 86 on page 67).

8.3 “UPS module” Option

To view voltage and current measurements and other information for each UPS module:

1. Use the ▼ and ▲ keys to scroll between UPS modules. The display shows the voltage and current measurements for each module (see Figure 102 on page 73).
2. Scroll ► and ◀ keys to view additional information for the specific module chosen.

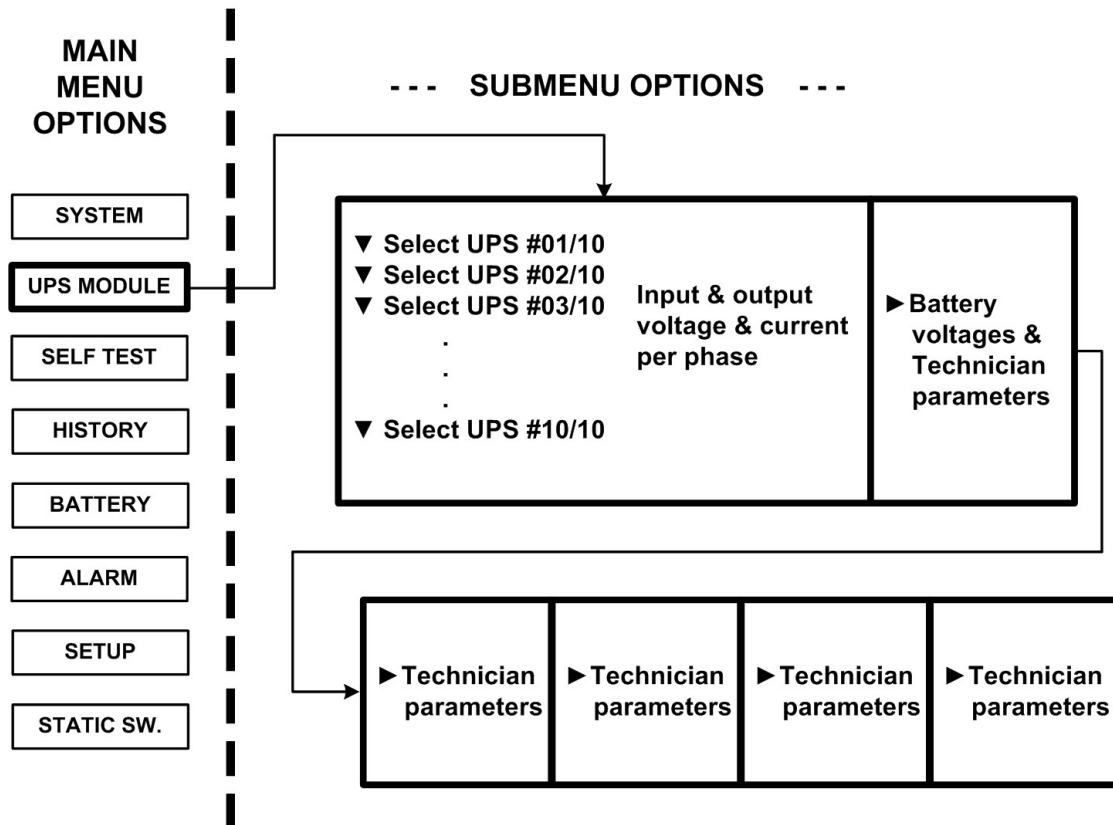

Figure 100: Main Menu option 2 (“UPS Module”)

1. The first screen to appear after selecting the UPS Module:

[Main Menu > UPS MODULE]

Next screens show data on all UPSs.
Use up, down arrow keys to select a UPS.
Use left, right arrow keys
to view different UPS parameters.

Figure 101: LCD Panel – select a UPS

2. View the input and output voltage and current for each phase of a particular UPS module. Scroll down ▼ to view other UPS modules.

[Main Menu > UPS MODULE > ▼]

PHASE:	-L1--	-L2--	-L3-
I N:	000V/000.0A	000V/000.0A	000V/000.0A
OUT:	000V/000.0A	000V/000.0A	000V/000.0A
UPS: #	01/04		

Figure 102: Module phase voltages/currents

3. View the battery voltage for the selected UPS module (the parameters I-ACTIVE and I-BUS are for a technician only).

[Main Menu > UPS MODULE > ▼ > ►]

BATT	VOLT	I -ACTIVE	I - BUS
BATT+:	216V	L1 000	L1 000
BATT-:	216V	L2 000	L2 000
UPS: #01/04		L3 000	L3 000

Figure 103: Battery voltages & technician parameters

8.4 “Self-test” Option

You can run a self-test at any time without interfering in the normal operation of the **POWER+**. A self-test is also initiated by the **POWER+** itself each day at midnight.

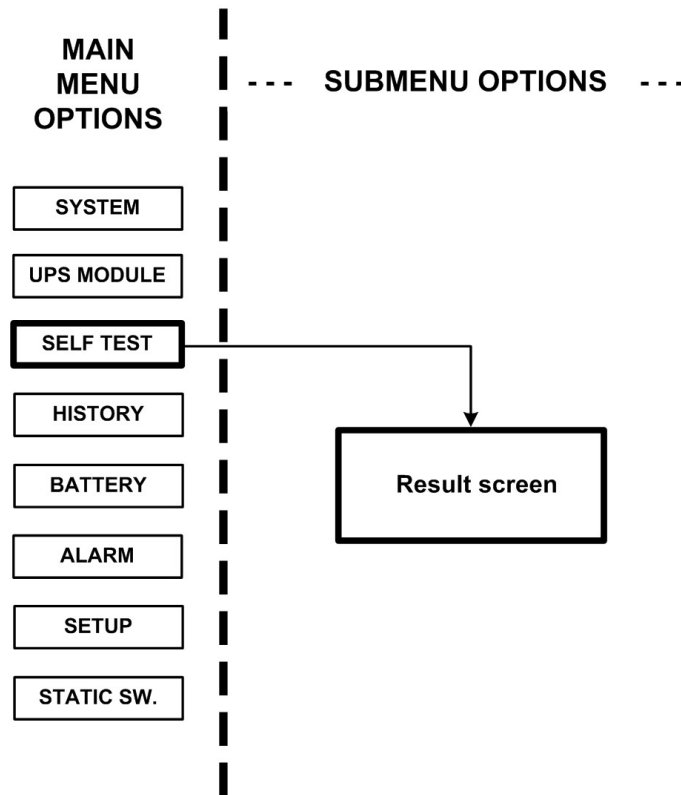

Figure 104: Main Menu option 3 (“Self Test”)

The failure of a self-test sets on the self-test alarm. The self-test alarm can only be cleared by a subsequent successful self test, or it can be cleared manually by a maintenance technician.

Powering the **POWER+** down and up, for example, does not clear the self-test alarm. This is because the failure of a self-test is considered a serious event that should not be “forgotten”. A self-test failure is also recorded in the alarm log.

[Main Menu > SELFTEST]

```

Wait for results...
STATIC RAM: PASSED   R. T   CLOCK: PASSED
EEPROM – 1: PASSED
EEPROM – 3: PASSED   DC SUPPLIES: PASSED
  
```

Figure 105: Result screen from self-test

8.5 “History” (logs) Option

The last 255 events reserved in the LOG are displayed, as shown in Figure 107.

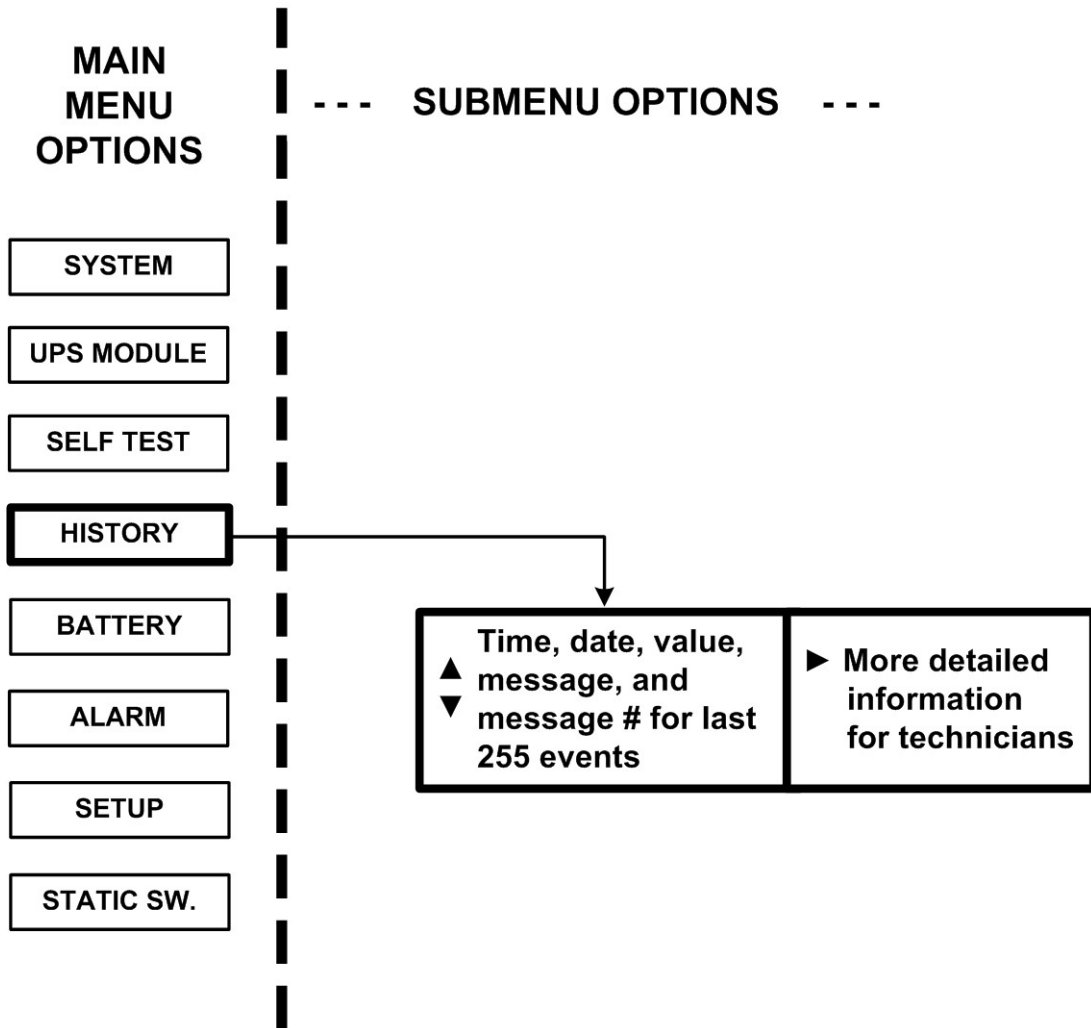

Figure 106: Main Menu option 4 (“History”)

1. Navigate the LOG by scrolling using the ▲ and ▼ keys.

[Main Menu > HISTORY]

TIME	DATE	VALUE	MESSAGE	#
14:36:16	28.06.07	099.1V	IN->STSWCM	254
14:37:01	28.06.07	502.0V	OUT>OVLOAD	255
12:27:26	27.06.07	120.0V	IN->UPS-CM	000

Figure 107: History logs

- View more details by pressing the ► key.

[Main Menu > HISTORY > ►]

TIME	DATE	1	2	3	4	5	6	7	8	#
14:36:16	28.02.10	○	○	○	○	○	○	○	○	254
14:37:01	28.02.10	○	○	○	○	○	○	○	○	255
12:27:26	27.02.10	○	○	○	○	○	○	○	○	000

Figure 108: History log scroll

Table 12 lists the log messages that can appear on the controller panel.

Table 12: Log Messages

#	Message	Explanation
01	UPSMAJ	More than 1 UPS Module is sending an alarm or fault warning
02	UPSMIN	Single UPS Module is sending an alarm or fault warning
03	-----	N.A.
04	-----	N.A.
05	LOADBP	Load is now running on bypass. See Table 13 on page 78 to interpret the LOADBP value.
06	VIBRA_	Alarm(s) vibrating. Alarm is frequently raised and lowered. Ignore to avoid loading the log filling up.
07	OVTEMP	Excess temperature
08	OUTFLT	No AC output to load
09	BAT-HI	Excessive battery voltage
10	-----	N.A.
11	BATEND	End of battery backup. Battery is discharged to shutdown limit
12	BATLOW	Low battery voltage
13	STSWRN	Static Switch Warning or alarm
14	E.P.O.	Emergency Power Off is active
15	EQ-HST	Battery is currently charging in equalizing mode, dc voltage is temporarily increased
16	BATFLT	Batteries failed last test
17	USER-1	User 1 input open
18	USER-2	User 2 input open
19	USER-3	User 3 input open
20	AC-BRN	Input AC supply Brown Out
21	ACIN_H	AC input excessive
22	ACFAIL	AC input failure
23	STSWCM	Static Switch does not respond
24	SLFFLT	Last controller self-test failed
25	BAT-CB	Battery Circuit Breaker Open
26	CURSHR	Current Sharing fault, load current is not equally divided between modules
27	UPSOUT	Fault (no current) in 1 or more output stage
28	UPSHDN	UPS shutdown by EPO, Battery Discharge, ON/OFF pressed

#	Message	Explanation
29	OVLOAD	Load current is high
30	UPS-CM	One or more UPS's not responding
31	STRTUP	Startup time-stamp
32	-----	N.A.

Each message is formatted as follows:

Time – HH:MM:SS

Date – YY:MM:DD

Data – DC voltage between + and – terminals for all events except LOADBP and STSW status for LOADBP events. (See below.)

Even start (IN) and end (OUT)

Description – (See Table 12 above)

Event number – 0 through 255, 255 being the most recent

Example:

11:23:56 10.01.28 865 IN -> E.P.O. 254

This message means that at 11:23:56 on January 28th 2010, Emergency Power Off alarm was registered as event 254; dc voltage at the time was 865 V being a sum of (V+ -N) and (V- -N).

Table 13: Interpreting the Static Switch transfer code (LOADBP)

The STSW transfer code, given as a decimal, is the sum of the eight components listed in this table. Each component has its own weight if detected, and a weight of zero if not detected.	
COMPONENT WEIGHT	CONDITION DESCRIPTION
1	Inverter voltage blackout for >3 ms.
2	Inverter peak voltage low (brownout) (<185 V for 3x400 V, <92.5 V for 3x208 V).
4	Inverter peak voltage high (>400 V for 3x400 V, >200 V for 3x208 V).
8	Frequency beyond limits (45-65 Hz).
16	Inverter average voltage low (<185 V for 3x400 V, <92.5 V for 3x208 V).
32	Inverter average voltage high (>260 V for 3x400 V, >130 V for 3x208 V)..
64	Load transfer command received from the controller (not manual).
128	Load transfer command received from the Static Switch (manual key press).

Example: If LOADBP data = 67 = (64+2+1), this means that three conditions were present:

- (64) Instruction to transfer the load was issued by the controller.
- (2) Low peak voltage detected.
- (1) Voltage blackout encountered.

8.6 “Battery” Option

The battery option on the main menu displays information about battery capacity, battery voltage and current, and battery test.

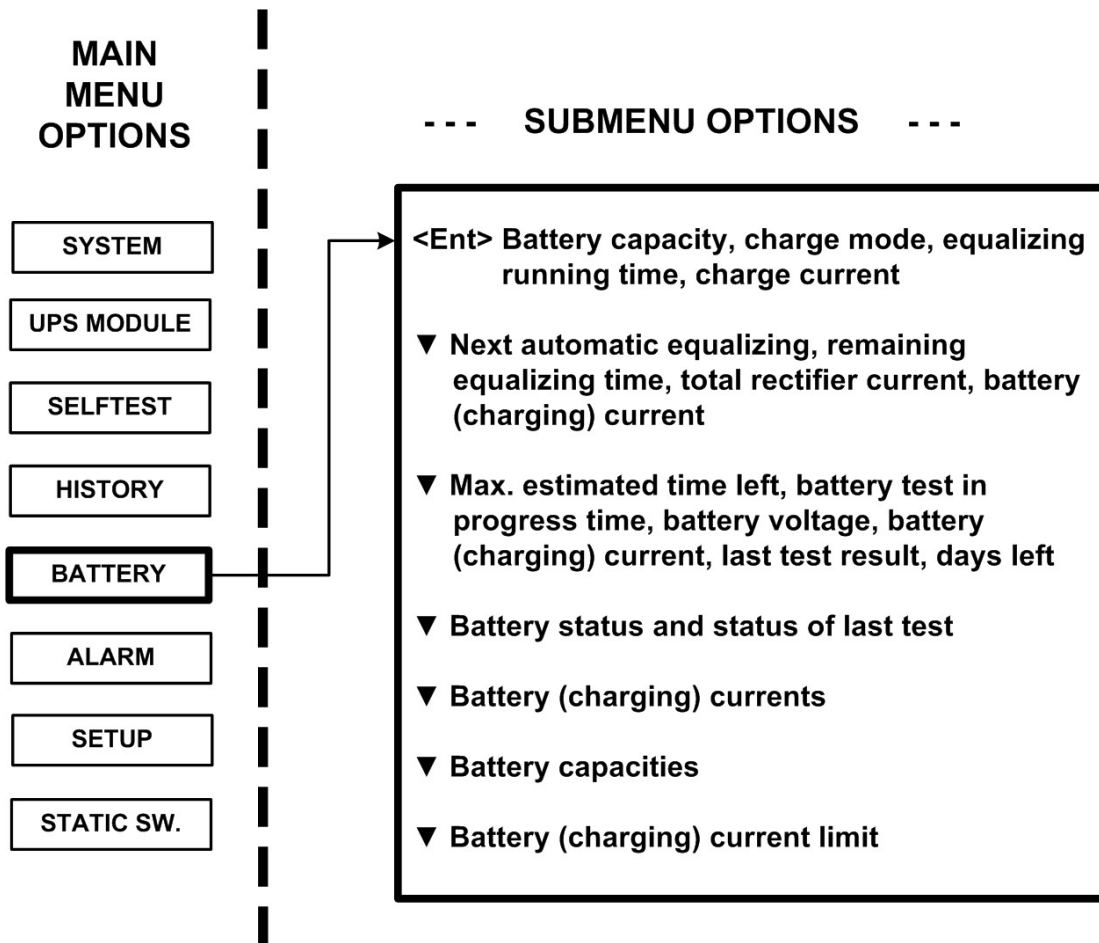

Figure 109: Main Menu option 5 (“Battery”)

1. View the battery capacity, charge mode, equalizing running time, and charge current:

[Main Menu > BATTERY]

```

Battery capacity: 0020Ah
Charge mode      : Floating
Eq. running time: -----
Charge current  : 053.0A
    
```

Figure 110: Battery status

- View next automatic equalizing, remaining equalizing time, total rectifier current, and battery (charging) current:

[Main Menu > BATTERY > ▼]

```
Next automatic equalizing: 02 days
Remaining equalizing time: ___ minutes
Rectifiers total current : 0050A
Battery current           : 053.0A
```

Figure 111: Battery equalizing

- View the maximum estimated time left, battery test in progress time, battery voltage, battery (charging) current, last test result, and days left:

[Main Menu > BATTERY > ▼ > ▼]

```
Max/estim time left : 00:00:00 /--:--:--
Battery test in progress for: 00:00:00
Batt. volt: 400.0V  Batt.current: 010
Last test: PASSED      Days left: 027
```

Figure 112: Time left

- View battery status and status of the last test:

[Main Menu > BATTERY > ▼ > ▼ > ▼]

```
1> Battery#1: PASSED  Last test: PASSED
```

Figure 113: Last test

- View battery (charging) current:

[Main Menu > BATTERY > ▼ > ▼ > ▼ > ▼]

```
Batt1 curr: 052.1A  Batt curr: 052.1A
```

Figure 114: Battery current

6. View battery capacity:

[Main Menu > BATTERY > ▼> ▼> ▼> ▼> ▼]

1> Battery#1: 020 Ah Total Cap. : 0020 Ah

Figure 115: Battery capacity

- **Note:** Figure 113, Figure 114, and Figure 115 show the individual batteries on the left and the overall total on the right. In the examples shown above, only one battery is installed.

7. View battery (charging) current limit:

[Main Menu > BATTERY > ▼> ▼> ▼> ▼> ▼]

1> Battery#1: Current limit: 53A

Figure 116: Battery current limit

8.7 “Alarm” Option

Alarms are displayed—there are 32 in all. In addition, there are some screens for use by a technician.

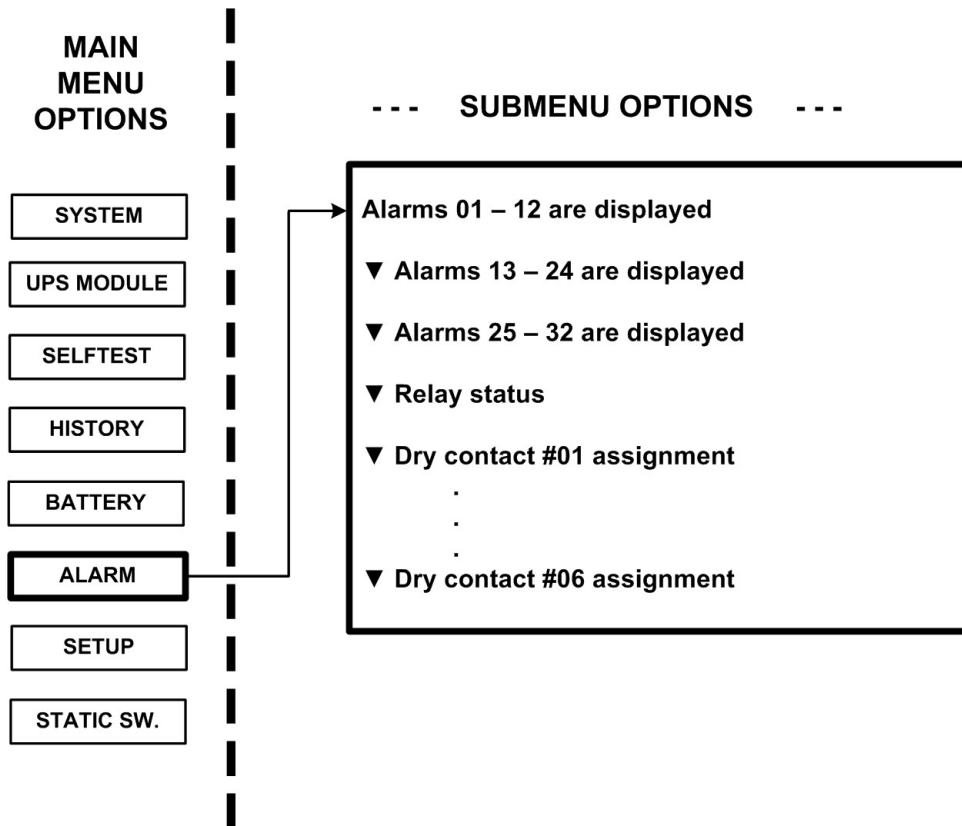

Figure 117: Main Menu option 6 (“Alarm”)

1. View alarms 01-12:

A + or – before an alarm name indicates the alarm is enabled or disabled, respectively.

An asterisk (*) after an alarm name indicates that the alarm is active.

[Main Menu > ALARM]

01 – 03	+UPSMAJ: *	+UPSMI N:	+MSTR>1:
04 – 06	+DCRPCY:	+LOADBP:	-VI BRA-:
07 – 09	+OVTEMP:	+OUTFLT:	+BAT-HI :
10 – 12	+-----:	+BATEND:	+BATLOW:

Figure 118: Alarms 01-12

2. View alarms 13-24:

[Main Menu > ALARM > ▼]

13 – 15	+STSWRN:	+E. P. O. : *	-EQ-HST:
16 – 18	+BATFLT: *	+USER-1:	-USER-2:
19 – 21	+USER-3:	+AC-BRN:	+ACIN-H:
22 – 24	+ACFAI L:	+STSWCM: *	+SLFFLT: *

Figure 119: Alarms 13-24

3. View alarms 25-32:

[Main Menu > ALARM > ▼ > ▼]

25 – 27	+BAT-CB:	+CURSHR: *	-UPSOUT:
28 – 30	+UPSHDN: *	+OVLOAD:	-UPS-CM:
31 – 32	+STRTUP:	+USER-4:	

Figure 120: Alarms 25-32

8.8 "Setup – Alarm Set" Option

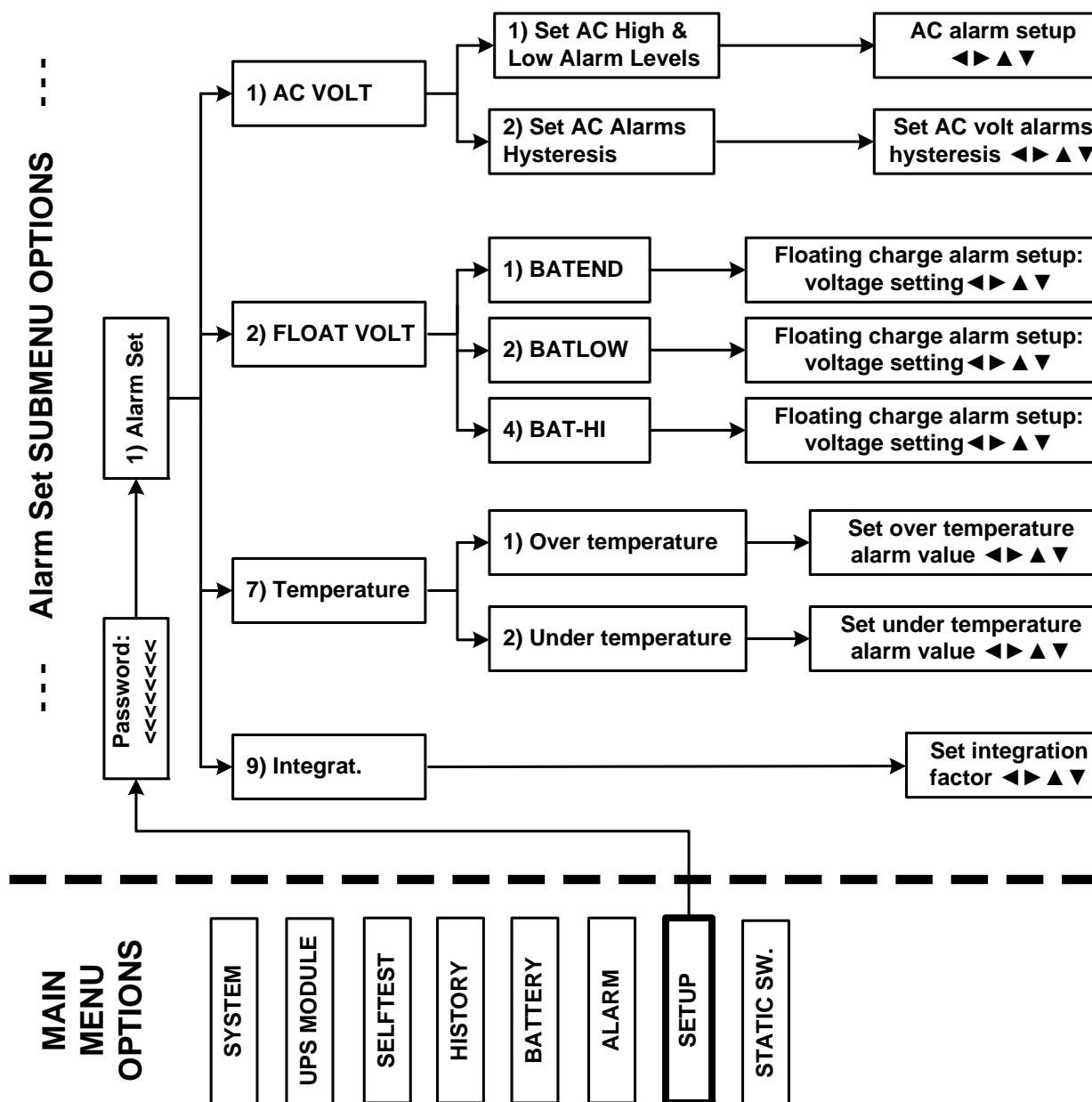

Figure 121: Main Menu option 7 ("Setup – Alarm Set")

- To enter Setup, use the default password <<<<<<<< (left arrow key eight times).

[Main Menu > SETUP]

POWER+ System Setup

Type in Level -1 PASSWORD, THEN – ENTER
Your privilege will expire after 15 mi.n.
PASSWORD: _____

Figure 122: Level 1 password access

2. Select Alarm set:

[Main Menu > SETUP > (password) > Ent]

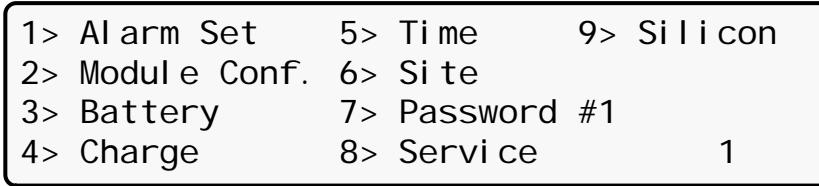

Figure 123: Setup menu

8.8.1 Setting Ac Voltage Alarms

1. Select **AC VOLT**:

[Main Menu > SETUP > (password) > ALARM SET]

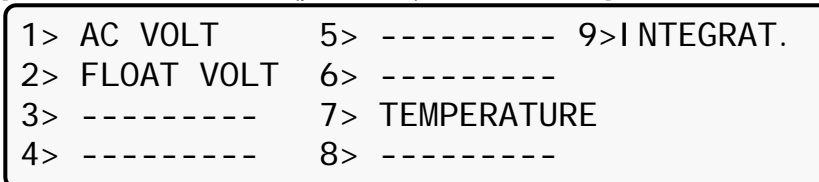

Figure 124: Alarm setup menu

2. Select **Set AC High & Low Alarm Levels**:

[Main Menu > SETUP > Ent > (password) > Ent > ALARM SET > AC VOLT]

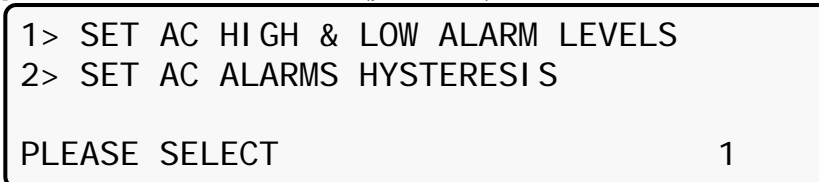

Figure 125: Ac alarms menu

3. Use the arrow keys to update values and press **Ent**:

[Main Menu > SETUP > Ent > (password) > Ent > ALARM SET > AC VOLT > Set AC High & Low Alarm Levels]



Figure 126: Set ac alarm voltage levels

4. Select **Set AC Alarms Hysteresis**:

[Main Menu > SETUP > Ent > (password) > Ent > ALARM SET > AC VOLT]

```

1> SET AC HIGH & LOW ALARM LEVELS
2> SET AC ALARMS HYSTERESIS

PLEASE SELECT          1

```

Figure 127: Ac alarms menu

5. Use the arrow keys to set value, press **Ent**, and then **Esc**:

[Main Menu > SETUP > Ent > (password) > Ent > ALARM SET > AC VOLT > Set AC Alarms Hysteresis]

```

SET AC VOLT ALARMS HYSTERESIS VALUE
      (1 - 20) VOLT

      05

```

Figure 128: Set ac voltage hysteresis

8.8.2 Setting Battery Floating Voltage Alarm

1. Select **FLOAT VOLT**:

[Main Menu > SETUP > (password) > ALARM SET]

```

1> AC VOLT      5> -----  9> INTEGRAT.
2> FLOAT VOLT  6> -----
3> -----    7> TEMPERATURE
4> -----    8> -----

```

Figure 129: Alarm set menu

2. Select **BATEND**:

[Main Menu > SETUP > (password) > ALARM SET > FLOAT VOLT]

```

1> BATEND
2> BATLOW
3> -----
4> BAT-HI          SELECT ITEM: 1

```

Figure 130: Battery floating charge alarm setup menu

3. Use the arrow keys to set **BATEND** and press **Ent**:

[Main Menu > SETUP > (password) > ALARM SET > FLOAT VOLT > BATEND]

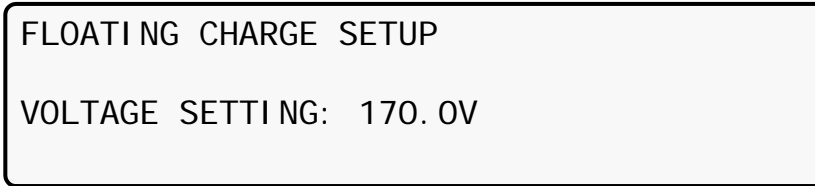

Figure 131: Set BATEND

4. Select **BATLOW**:

[Main Menu > SETUP > (password) > ALARM SET > FLOAT VOLT]



Figure 132: Battery floating charge alarm setup menu

5. Use the arrow keys to set **BATLOW** and press **Ent**:

[Main Menu > SETUP > (password) > ALARM SET > FLOAT VOLT > BATLOW]

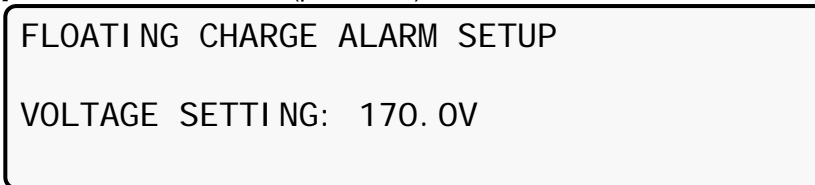

Figure 133: Set BATLOW

6. Select **BAT-HI**:

[Main Menu > SETUP > (password) > ALARM SET > FLOAT VOLT]

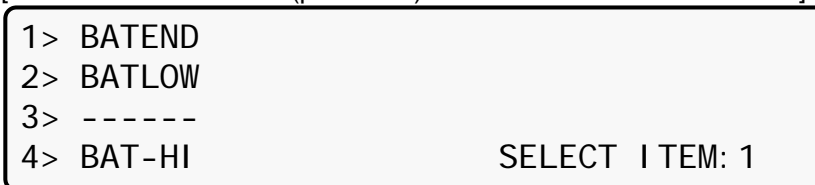

Figure 134: Battery floating charge alarm setup menu

- Use the arrow keys to set **BAT-HI**, press **Ent**, and then **Esc**:

[Main Menu > SETUP > (password) > ALARM SET > FLOAT VOLT > BAT-HI]

```
FLOATING CHARGE ALARM SETUP
VOLTAGE SETTING: 340.0V
```

Figure 135: Set BAT-HI

8.8.3 Setting Battery Over/Under Temperature Alarms

- Select **TEMPERATURE**:

[Main Menu > SETUP > (password) > ALARM SET]

```
1> AC VOLT      5> ----- 9>I NTEGRAT.
2> FLOAT VOLT  6> -----
3> -----    7> TEMPERATURE
4> -----    8> -----
```

Figure 136: Alarm set menu

- Select **OVER TEMPERATURE**:

[Main Menu > SETUP > (password) > ALARM SET > Temperature]

```
1> OVER TEMPERATURE
2> UNDER TEMPERATURE

PLEASE SELECT
```

Figure 137: Over/Under temperature menu

- Use the arrow keys to set the battery maximum temperature alarm value and press **Ent**:

[Main Menu > SETUP > (password) > ALARM SET > Temperature > OVER TEMPERATURE]

```
SET OVER TEMPERATURE ALARM VALUE
( 2 - 99) DEGREES
```

45

Figure 138: Set battery maximum temperature alarm

4. Select **UNDER TEMPERATURE**:

[Main Menu > SETUP > (password) > ALARM SET > Temperature]

```
1> OVER TEMPERATURE
2> UNDER TEMPERATURE

PLEASE SELECT
```

Figure 139: Over/Under temperature menu

5. Use the arrow keys to set the battery minimum temperature alarm value, press **Ent**, and then **Esc**:

[Main Menu > SETUP > (password) > ALARM SET > Temperature > UNDER TEMPERATURE]

```
SET OVER TEMPERATURE ALARM VALUE
      ( 2 – 99) DEGREES

      45
```

Figure 140: Set battery minimum temperature alarm

8.8.4 Setting Battery Integration Alarm

The Alarm Integration Factor determines the number of times that the controller polls and retries to determine the UPS status before deciding on an error status. Setting the alarm integration factor too low will cause spurious alarms to be generated; conversely, setting the alarm integration factor too high may result in an alarm only being raised when it is already too late to take corrective action.

1. Select **INTEGRAT.:**

[Main Menu > SETUP > (password) > ALARM SET]

```
1> AC VOLT      5> ----- 9>I NTEGRAT.
2> FLOAT VOLT  6> -----
3> -----    7> TEMPERATURE
4> -----    8> -----
```

Figure 141: Alarm set menu

2. Use the arrow keys to set the integration factor alarm value—press **Ent** to accept or **Esc** to discard:

[Main Menu > SETUP > (password) > ALARM SET > INTEGRAT.]

SET INTEGRATION FACTOR
(1 – 30)
ENTER = ACCEPT 05 ESC = DISCARD

Figure 142: Set the integration factor alarm

8.9 “Setup – Module Conf.” Option

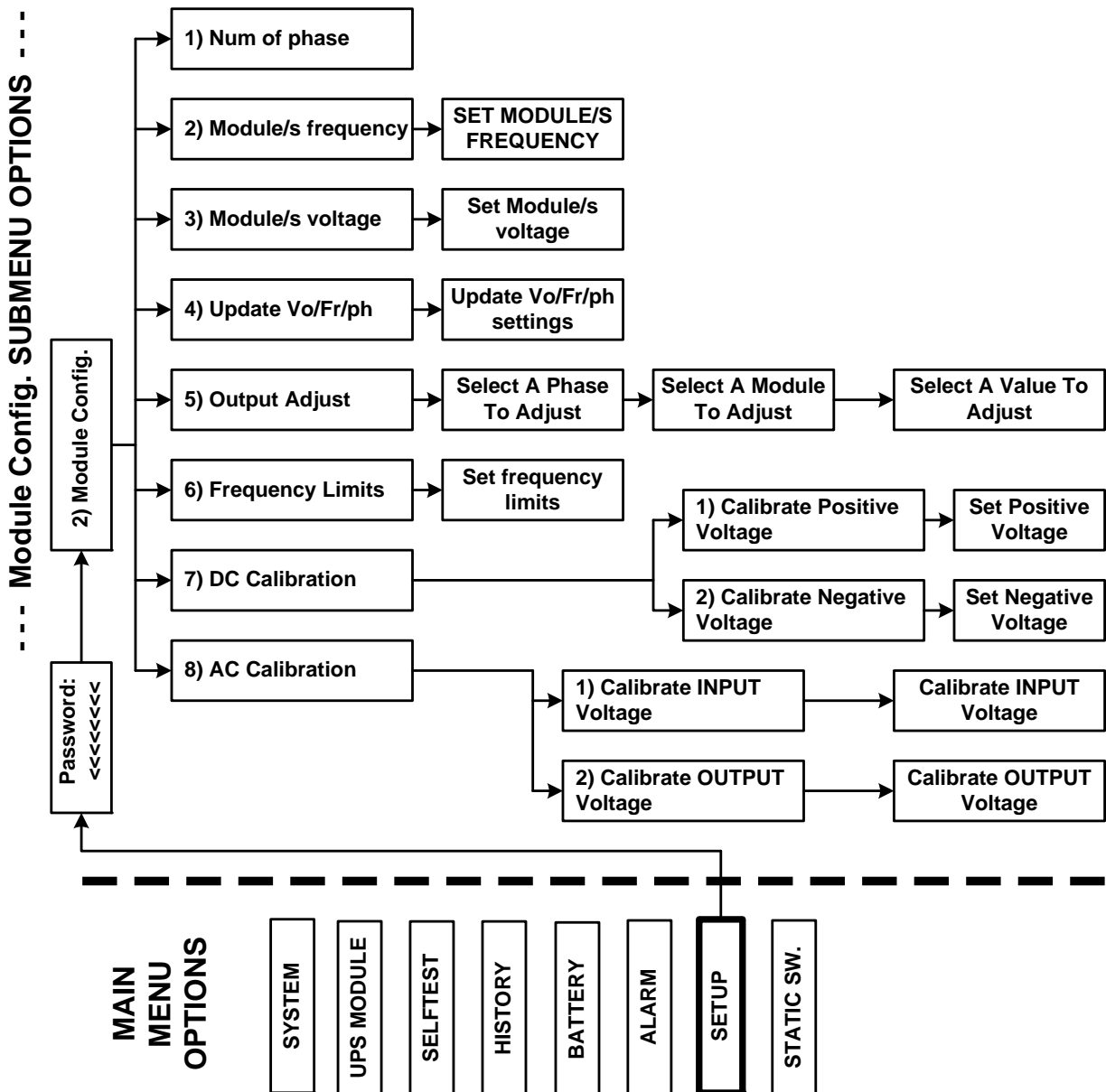

Figure 143: Main Menu option 7 (“Setup – Module Conf.”)

- To enter Setup, use the default password <<<<<<<<<<<< (left arrow key eight times).

[Main Menu > SETUP]

POWER+ System Setup

Type in Level -1 PASSWORD, THEN – ENTER
 Your privilege will expire after 15 min.
 PASSWORD: _____

Figure 144: Level 1 password access

2. Select **Module conf.:**

[Main Menu > SETUP > (password) > Ent]

1> Al arm set	5> Ti me	9> Si l i con
2> Modu le conf.	6> Si te	
3> Batt ery	7> Passw ord #1	
4> Char ge	8> Servi ce	

Figure 145: Setup menu

8.9.1 Setting Number of Phases

1. Select **Num of phase:**

[Main Menu > SETUP > (password) > Module conf.]

1. Num of phase	5. Output Adjust
2. Module/s frequency	6. Frequency Limits
3. Module/s voltage	7. DC Calibration
4. Update Vo/Fr/ph	8. AC Calibration

Figure 146: Module Config. setup menu

8.9.2 Setting Module/s Frequency

1. Select **Module/s frequency:**

[Main Menu > SETUP > (password) > Module conf.]

1. Num of phase	5. Output Adjust
2. Module/s frequency	6. Frequency Limits
3. Module/s voltage	7. DC Calibration
4. Update Vo/Fr/ph	8. AC Calibration

Figure 147: Module Config. setup menu

2. Use the ▲▼ arrow keys to set the module/s frequency, press **Ent**, and then **Esc**:

[Main Menu > SETUP > (password) > Module conf. > Module/s frequency]

---	SET MODULE/S FREQUENCY	---
SELECT - 1	HARD (DIP DEPEND.)	
SELECT - 2	SET 50HZ	(SELECTED)
SELECT - 3	SET 60HZ	

Figure 148: Setting the Module/s frequency

8.9.3 Setting Module/s Voltage

1. Select **Module/s voltage**:

[Main Menu > SETUP > (password) > Module conf.]

1. Num of phase	5. Output Adjust
2. Module/s frequency	6. Frequency Limits
3. Module/s voltage	7. DC Calibration
4. Update Vo/Fr/ph	8. AC Calibration

Figure 149: Module Config. setup menu

2. Use the ▲▼ arrow keys to set the module/s voltage, press **Ent**, and then **Esc**:

[Main Menu > SETUP > (password) > Module conf. > Module/s voltage]

Module/s voltage	4: 118V
1: 110V	5: 120V
2: 113V	6: 125V
3: 115V (selected)	5: 130V

Figure 150: Setting the Module/s voltage

8.9.4 Update Voltage/Frequency/Phase

1. Select **Update Vo/Fr/ph**:

[Main Menu > SETUP > (password) > Module conf.]

1. Num of phase	5. Output Adjust
2. Module/s frequency	6. Frequency Limits
3. Module/s voltage	7. DC Calibration
4. Update Vo/Fr/ph	8. AC Calibration

Figure 151: Module Config. setup menu

2. Press **Ent** to update, and then **Esc**:

[Main Menu > SETUP > (password) > Module conf. > Update Vo/Fr/ph]

Nominal Voltage & Frequency have been sent to all modules. Please verify all modules were updated! Exit this mode by pressing Esc.

Figure 152: Updating the Module/s voltage/frequency/phase

8.9.5 Output Adjustment

1. Select **Output Adjust**:

[Main Menu > SETUP > (password) > Module conf.]

```

1. Num of phase           5. Output Adjust
2. Module/s frequency    6. Frequency Limits
3. Module/s voltage      7. DC Calibration
4. Update Vo/Fr/ph      8. AC Calibration
  
```

Figure 153: Module Config. setup menu

2. Select a phase to adjust and press **Ent**:

[Main Menu > SETUP > (password) > Module conf. > Output Adjust]

```

----- Select a phase to adjust -----
Select - 1: L1
Select - 2: L2
Select - 3: L3
  
```

Figure 154: Select a phase to adjust

3. Using the ▲▼ keys, select a module to adjust, and then **Ent**:

[Main Menu > SETUP > (password) > Module conf. > Output Adjust > Ent]

```

----- Select a module to adjust -----
                                01
----- Use Up/Down, Enter, or Esc. -----
  
```

Figure 155: Select a module to adjust

4. Using the ▲▼ keys select a value to adjust, and then press **Ent**:

[Main Menu > SETUP > (password) > Module conf. > Output Adjust > Ent > Ent]

```

----- Set a value to adjust -----
                                Phase: 1
                                Module: 01
----- Use Up/Down, Enter, or Esc. -----
  
```

Figure 156: Select a value to adjust

8.9.6 Setting Frequency Limits

1. Select **Frequency Limits**:

[Main Menu > SETUP > (password) > Module conf.]

1. Num of phase	5. Output Adjust
2. Module/s frequency	6. Frequency Limits
3. Module/s voltage	7. DC Calibration
4. Update Vo/Fr/ph	8. AC Calibration

Figure 157: Module Config. setup menu

2. Using the **▲▼** keys set the frequency limits, press **Ent**, and then **Esc**:

[Main Menu > SETUP > (password) > Module conf. > Frequency Limits]

--- Set frequency limits ---	
1: No Change	4: +/- 3Hz
2: +/- 1Hz (slctd)	5: +/- 4Hz
3: +/- 2Hz	6: +/- 0.5Hz

Figure 158: Select the frequency limits

8.9.7 Calibrating DC Voltage

1. Select **DC Calibration**:

[Main Menu > SETUP > (password) > Module conf.]

1. Num of phase	5. Output Adjust
2. Module/s frequency	6. Frequency Limits
3. Module/s voltage	7. DC Calibration
4. Update Vo/Fr/ph	8. AC Calibration

Figure 159: Module Config. setup menu

2. Select either **Calibrate Positive Voltage** or **Calibrate Negative Voltage** and then press **Ent**:

[Main Menu > SETUP > (password) > Module conf. > DC Calibration]

--- MODULES DC VOLTAGE CALIBRATION ---
SELECT – 1: Calibrate Positive Voltage
SELECT – 2: Calibrate Negative Voltage
Then press ENTER to continue

Figure 160: Calibrate Positive or Negative Voltage

- Adjust the measured value using the arrow keys, and press **Ent** to update:

[Main Menu > SETUP > (password) > Module conf. > DC Calibration > Ent]

```

MODULE V. CALIB – 15 Sec to expire
##### Press ENTER To UPDATE #####
MEASURED VALUE: 216.0V

```

Figure 161: Enter measured value

8.9.8 Calibrating AC Voltage

- Select **AC Calibration**:

[Main Menu > SETUP > (password) > Module conf.]

```

1. Num of phase          5. Output Adjust
2. Module/s frequency   6. Frequency Limits
3. Module/s voltage     7. DC Calibration
4. Update Vo/Fr/ph      8. AC Calibration

```

Figure 162: Module Config. setup menu

- Select either **Calibrate INPUT Voltage** or **Calibrate OUTPUT Voltage** and then press **Ent**:

[Main Menu > SETUP > (password) > Module conf. > AC Calibration]

```

--- MODULES AC VOLTAGE CALIBRATION ---
SELECT – 1: Calibrate INPUT Voltage
SELECT – 2: Calibrate OUTPUT Voltage
Then press ENTER to continue

```

Figure 163: Calibrate INPUT or OUTPUT Voltage

- Adjust the measured value using the arrow keys, and press **Ent** to update:

[Main Menu > SETUP > (password) > Module conf. > AC Calibration > Ent]

```

MODULE V. CALIB – 15 Sec to expire
##### Press ENTER To UPDATE #####
MEASURED VALUE: 120.0V

```

Figure 164: Enter measured value

1. To enter Setup, use the default password <<<<<<<< (left arrow key eight times).

[Main Menu > SETUP]

```

POWER+ System Setup
Type in Level -1 PASSWORD, THEN - ENTER
Your privilege will expire after 15 min.
PASSWORD: _____
    
```

Figure 166: Level 1 password access

2. Select **Battery**:

[Main Menu > SETUP > (password) > Ent]

```

1> Alarm set      5> Time          9> Silicon
2> Module conf.  6> Site
3> Battery        7> Password #1
4> Charge         8> Service
    
```

Figure 167: Setup menu

8.10.1 Setting Battery Test Voltage

1. Select **Test-Voltage**:

[Main Menu > SETUP > (password) > Battery]

```

1> Test-Voltage  5> Battery test...
2> Test Alarm    6> Capacity 0020 AH)
3> Current-Limit.. 7> 'Auto' Test
4> Temp Compensat. 8> Enable/Dis Options
    
```

Figure 168: Battery setup menu

2. Using the arrow keys, set the battery test voltage and press **Ent**:

[Main Menu > SETUP > (password) > Battery > Test Voltage]

```

BATTERY (TEST) VOLTAGE SETUP

VOLTAGE SETTING: 176.0V
    
```

Figure 169: Set battery test voltage

8.10.2 Setting Battery Test Voltage Alarm

1. Select **Test Alarm**:

[Main Menu > SETUP > (password) > Battery]

1> Test-Voltage	5> Battery test...
2> Test Alarm	6> Capacity 0020 AH)
3> Current-Limit..	7> 'Auto' Test
4> Temp Compensat.	8> Enable/Dis Options

Figure 170: Battery setup menu

2. Using the arrow keys, set the battery test voltage alarm and press **Ent**:

[Main Menu > SETUP > (password) > Battery > Test Alarm]

BATTERY (TEST) VOLTAGE ALARM	180.0 V
------------------------------	---------

Figure 171: Set battery test voltage alarm

8.10.3 Setting Battery Current Limit

1. Select **Current-Limit...**:

[Main Menu > SETUP > (password) > Battery]

1> Test-Voltage	5> Battery test...
2> Test Alarm	6> Capacity 0020 AH)
3> Current-Limit..	7> 'AuTo' Test
4> Temp Compensat.	8> Enable/Dis Options

Figure 172: Battery setup menu

2. Select **Current Limit Value Setup** and press **Ent**:

[Main Menu > SETUP > (password) > Battery > Current Limit]

1> Current Limit Value Setup
2> Current Limit – Press to ENABLE
1
Press '2' to Toggle Enable / Disable

Figure 173: Current Limit setup menu

3. Select the current limit for each battery and press **Ent**:

[Main Menu > SETUP > (password) > Battery > Current Limit >Ent]

1> Set C. Limit of Battery #1 (99A)

Figure 174: Current limit indication for (each) battery

4. Using the arrow keys, set the current limit for each battery. After the current limit is set for all batteries, press **Esc**.

[Main Menu > SETUP > (password) > Battery > Current Limit >Ent > Ent]

CHARGE CURRENT LIMIT SETUP
CURRENT LIMIT: 99A

Figure 175: Set Current limit for (each) battery

8.10.4 Enable/Disable Battery Current Limit

1. Select **Current-Limit...**:

[Main Menu > SETUP > (password) > Battery]

1> Test-Voltage	5> Battery test...
2> Test Alarm	6> Capacity 0020 AH)
3> Current-Limit..	7> 'AuTo' Test
4> Temp Compensat.	8> Enable/Dis Options

Figure 176: Battery setup menu

2. Select **Current Limit Value Setup** and press **Ent**:

[Main Menu > SETUP > (password) > Battery > Current Limit]

1> Current Limit Value Setup
2> Current Limit – Press to ENABLE
Press '2' to Toggle Enable / Disable

Figure 177: Current Limit setup menu

3. Select **Current Limit – Press to ENABLE** and press **Ent** to toggle ENABLE/DISABLE:

[Main Menu > SETUP > (password) > Battery > Current Limit]

1> Current Limit Value Setup
2> Current Limit – Press to ENABLE
Press '2' to Toggle Enable / Disable

1> Current Limit Value Setup
2> Current Limit – Press to DISABLE
Press '2' to Toggle Enable / Disable

Figure 178: Enable/Disable current limit

8.10.5 Setting Temperature Compensation

1. Select **Temp Compensat.:**

[Main Menu > SETUP > (password) > Battery]

```

1> Test-Voltage      5> Battery test...
2> Test Alarm       6> Capacity 0020 AH)
3> Current-Limit.. 7> 'Auto' Test
4> Temp Compensat. 8> Enable/Dis Options
  
```

Figure 179: Battery setup menu

2. Select **Temperature compensation Value Setup** and press **Ent**:

[Main Menu > SETUP > (password) > Battery > Temp Compensat.]

```

1> Temperature Compensation Value Setup
2> Disable Temp. Compensation (2.0 mV)
3> Set ABSOLUTE Max & Min Voltages 1
Press '2' to toggle enable / disable
  
```

Figure 180: Temperature compensation setup menu

3. Use the arrow keys to set the temperature compensation and press **Ent**:

[Main Menu > SETUP > (password) > Battery > Temp Compensat. >Ent]

```

Temperature Compensation Setup
                2.0 - 4.0
Compensate      : 2.0 mV/°C (Per Cell)
  
```

Figure 181: Set temperature compensation

8.10.6 Setting Disable Temperature Compensation

1. Select **Temp Compensat.:**

[Main Menu > SETUP > (password) > Battery]

1> Test-Voltage	5> Battery test...
2> Test Alarm	6> Capacity 0020 AH)
3> Current-Limit..	7> 'Auto' Test
4> Temp Compensat.	8> Enable/Disable Options

Figure 182: Battery setup menu

2. Select **Enable Temp. Compensation** and press **Ent** to toggle enable/disable:

[Main Menu > SETUP > (password) > Battery > Temp.Compensat.]

1> Temperature Compensation Value Setup
2> Enable Temp. Compensation (OFF)
3> Set ABSOLUTE Max & Min Voltages 1
Press '2' to toggle enable / disable

1> Temperature Compensation Value Setup
2> Disable Temp. Compensation (2.0 mV)
3> Set ABSOLUTE Max & Min Voltages 1
Press '2' to toggle enable / disable

Figure 183: Enable/Disable temperature compensation

8.10.7 Setting Absolute Maximum and Minimum Voltages

1. Select **Set ABSOLUTE Max & Min Voltages:**

[Main Menu > SETUP > (password) > Battery > Temp. Compensat.]

1> Temperature Compensation Value Setup
2> Enable Temp. Compensation (OFF)
3> Set ABSOLUTE Max & Min Voltages 1
Press '2' to toggle enable / disable

Figure 184: Select Set ABSOLUTE Max & Min Voltages

2. Select **Set absolute minimum output voltage**:

[Main Menu > SETUP > (password) > Battery > Temp. Compensat. > Set ABSOLUTE Max & Min Voltages]

```

1> Set absolute minimum output voltage
2> Set absolute maximum output voltage
---= Active in floating mode only =---
Please select.                               1

```

Figure 185: Select Set absolute minimum output voltage

3. Using the arrow keys, set the absolute minimum voltage when compensating and then press **Ent**:

[Main Menu > SETUP > (password) > Battery > Temp. Compensat. > Set ABSOLUTE Max & Min Voltages > Absolute MINimum Voltage While Cmpensat.]

```

Absolute minimum voltage while cmpensat.

Voltage setting: 400.0V

```

Figure 186: Set absolute minimum output voltage when compensating

4. Select **Set absolute maximum output voltage**:

[Main Menu > SETUP > (password) > Battery > Temp. Compensat. > Set ABSOLUTE Max & Min Voltages]

```

1> Set absolute minimum output voltage
2> Set absolute maximum output voltage
---= Active in floating mode only =---
Please select.                               1

```

Figure 187: Select Set absolute maximum output voltage

5. Using the arrow keys, set the absolute maximum voltage when compensating, press **Ent**, and then **Esc**:

[Main Menu > SETUP > (password) > Battery > Temp. Compensat. > Set ABSOLUTE Max & Min Voltages > Absolute MAXimum Voltage While Cmpensat.]

```

Absolute maximum voltage while cmpensat.

Voltage setting: 460.0V

```

Figure 188: Set absolute maximum output voltage when compensating

8.10.8 Activating the Battery Test

1. Select **Battery test...**:

[Main Menu > SETUP > (password) > Battery]

```
1> Test-Voltage      5> Battery test...
2> Test Alarm       6> Capacity 0020 AH)
3> Current-Limit.. 7> 'AuTo' Test
4> Temp Compensat. 8> Enable/Dis Options
```

Figure 189: Battery setup menu

2. Select **Activate Battery Test...** and press **Ent**:

[Main Menu > SETUP > (password) > Battery > Battery test...]

```
1> Activate battery test...
2> Set auto battery test period
3> Set auto battery test top time
1
```

Figure 190: Select Activate Battery Test...

3. Press **Ent** to start/stop test, and then press **Esc**:

[Main Menu > SETUP > (password) > Battery > Battery test...]

```
Max/estim. Time left: 05:27:00 /--: --: --
Battery test in progress for: 00:00:00
Batt. volt: 432V Batt. Current: ---
Press 'Enter' to start.
```

Figure 191: Activate battery test

8.10.9 Setting the Automatic Battery Test Period

1. Select **Battery test...**:

[Main Menu > SETUP > (password) > Battery]

```
1> Test-Voltage      5> Battery test...
2> Test Alarm       6> Capacity 0020 AH)
3> Current-Limit.. 7> 'AuTo' Test
4> Temp Compensat. 8> Enable/Dis Options
```

Figure 192: Battery setup menu

2. Select **Set Auto Battery Test Period** and then press **Ent**:

[Main Menu > SETUP > (password) > Battery > Battery test...]

```

1> Activate battery test...
2> Set auto battery test period
3> Set auto battery test top time

```

1

Figure 193: Select Set auto battery test period

3. Using the arrow keys, set the battery test period and then press **Ent**:

[Main Menu > SETUP > (password) > Battery > Battery test...> Set Auto Battery Test Period]

```

Set batt test period
      (1 – 50) weeks
      --

```

Figure 194: Set battery test period

8.10.10 Setting the Automatic Battery Test Top Time

1. Select **Battery test...:**

[Main Menu > SETUP > (password) > Battery]

```

1> Test-Voltage      5> Battery test...
2> Test Alarm       6> Capacity 0020 AH)
3> Current-Limit.. 7> 'AuTo' Test
4> Temp Compensat. 8> Enable/Dis Options

```

Figure 195: Battery setup menu

2. Select **Set Auto Battery Test Top Time** and then press **Ent**:

[Main Menu > SETUP > (password) > Battery > Battery test...]

```

1> Activate battery test...
2> Set auto battery test period
3> Set auto battery test top time

```

1

Figure 196: Select Set auto battery test top time

- Using the arrow keys, set the battery test top time, and then press **Ent**:

[Main Menu > SETUP > (password) > Battery > Battery test...> Set Auto Battery Test Top Time]

```
Set top time for battery test
                (1 - 9) hours

Enter = accept      05      Esc = di scard
```

Figure 197: Set battery test top time

8.10.11 Setting the Nth Battery Capacity

- Select **Capacity 0020AH**:

[Main Menu > SETUP > (password) > Battery]

```
1> Test-Voltage      5> Battery test...
2> Test Alarm        6> Capacity 0020 AH)
3> Current-Limit..  7> 'AuTo' Test
4> Temp Compensat.  8> Enable/Di s Options
```

Figure 198: Battery setup menu

- Select **Set Capacity of Battery #1** and then press **Ent**:

[Main Menu > SETUP > (password) > Battery > Capacity 00020AH]

```
1> Set capaci ty of battery #1   (020 Ah)
```

Figure 199: Select Set capacity of battery #1

- Using the arrow keys, set the battery capacity, press **Ent**, and then set the capacity for the next battery, if any:

[Main Menu > SETUP > (password) > Battery > Capacity 00020AH) > Set Capacity of Battery #1]

```
Battery #01   Capaci ty setup
                10 -990
Capaci ty      : 020 Ah
```

Figure 200: Set battery capacity

Press **Esc** after setting all battery capacities.

8.10.12 Activating 'Auto' Test

1. Select '**AuTo**' Test:

[Main Menu > SETUP > (password) > Battery]

```

1> Test-Voltage      5> Battery test...
2> Test Alarm       6> Capacity 0020 AH)
3> Current-Limit.. 7> 'AuTo' Test
4> Temp Compensat. 8> Enable/Dis Options
  
```

Figure 201: Battery setup menu

2. The test is performed. Press **Ent** when done.

[Main Menu > SETUP > (password) > Battery > 'Auto' Test]

```

Max/estim time left : 00:00:00 /--: --: --
Battery test in progress for: 00:00:00
Batt. volt: 400.0V  Batt.current: 010
Last test: PASSED      Days left: 027
  
```

Figure 202: Activated 'Auto' test

8.10.13 Enabling/Disabling Options

1. Select **Enable/Dis Options**:

[Main Menu > SETUP > (password) > Battery]

```

1> Test-Voltage      5> Battery test...
2> Test Alarm       6> Capacity 0020 AH)
3> Current-Limit.. 7> 'AuTo' Test
4> Temp Compensat. 8> Enable/Dis Options
  
```

Figure 203: Battery setup menu

2. Select **ENABLE SHUTDOWN by long AC FAIL (Off)** and press **Ent** to toggle enable/disable:

[Main Menu > SETUP > (password) > Battery > Enable/Dis Options]

1> ENABLE SHUTDOWN by long AC FAIL (Off)
2> ENABLE Current Sensors (Off)
3> ENABLE BATT Temperature sensor (Off)
Select & Press To toggle Enable/Disable

1> DISABLE SHUTDOWN by long AC FAIL(On)
2> ENABLE Current Sensors (Off)
3> ENABLE BATT Temperature sensor (Off)
Select & Press To toggle Enable/Disable

Figure 204: Enable/Disable shutdown by long AC failure

Note: Option 1 in Figure 204 allows the user to enforce shutdown after a given length of input ac failure, even when the batteries are still fully charged.

Item 2, **ENABLE Current Sensors (Off)** and item 3, **ENABLE BATT Temperature sensor (Off)** in the screens shown in Figure 204 toggle between enable/disable in the same manner as item 1, **ENABLE SHUTDOWN by long AC FAIL (Off)**.

8.11 Setup – Charge, Time, Site, and Password Options

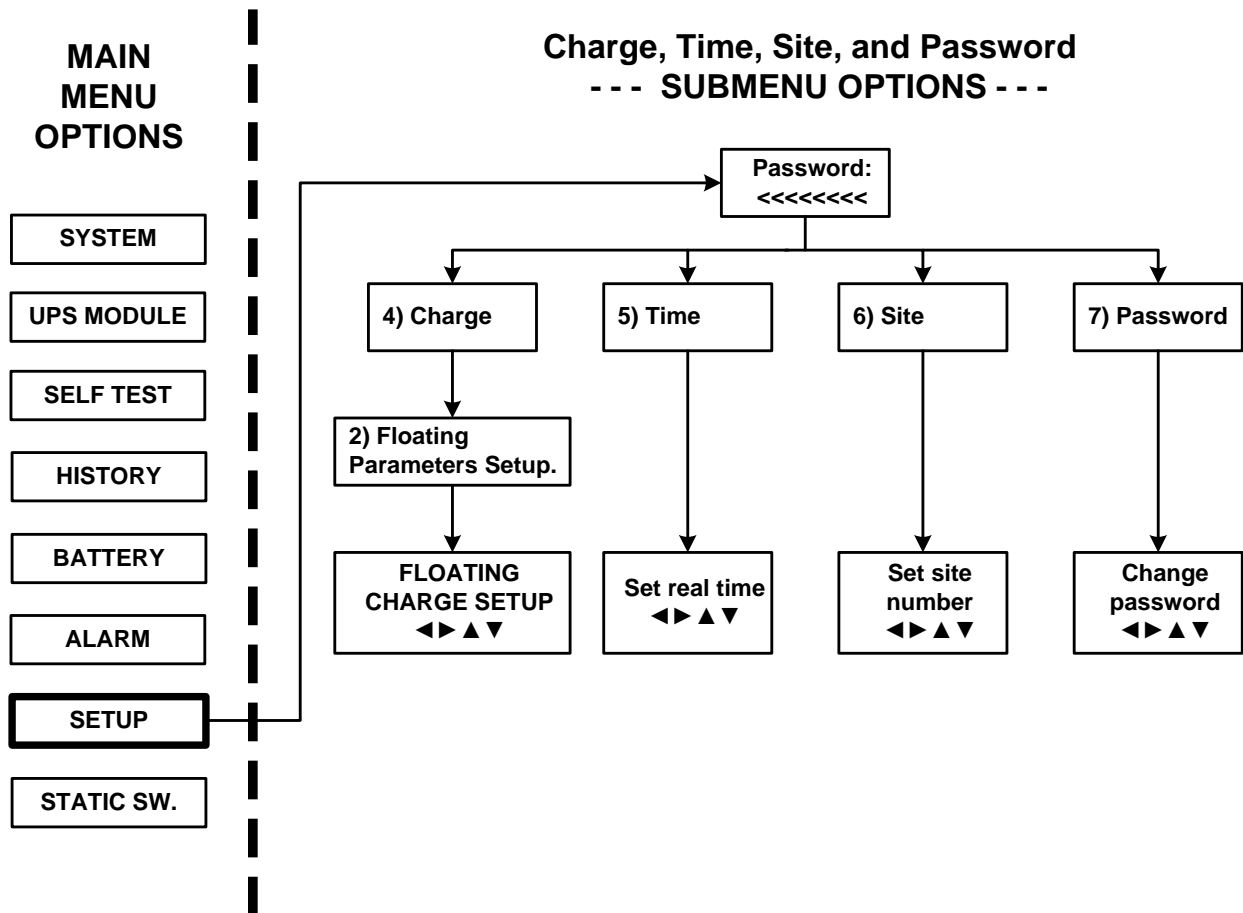

Figure 205: Main Menu option 7 (“Setup – Charge, Time, Site, & Password”)

1. To enter Setup, use the default password <<<<<<<< (left arrow key eight times).

[Main Menu > SETUP]

POWER+ System Setup

Type in Level -1 PASSWORD, THEN – ENTER
 Your privilege will expire after 15 mi.n.
 PASSWORD: _____

Figure 206: Level 1 password access

8.11.1 Setting the Floating Charge

1. Select Charge:

[Main Menu > SETUP > (password) > Ent]

```
1> Al arm set      5> Ti me      9> Si li con
2> Modul e conf.  6> Si te
3> Battery        7> Password #1
4> Charge         8> Servi ce
```

Figure 207: Setup menu

2. Select **Floating parameters setup.**:

[Main Menu > SETUP > (password) > Charge]

```
1> -----
2> Floating parameters setup.
3> ----- (Eq: off)
4> ----- 1
```

Figure 208: Charge setup menu

3. Using the arrow keys, set the floating charge, press **Ent**, and then press **Esc**:

[Main Menu > SETUP > (password) > Charge > Floating parameters setup.]

```
Floating charge setup
Voltage setting: 432.0V
```

Figure 209: Set floating charge

8.11.2 Setting the Time

1. Select **Time**:

[Main Menu > SETUP > (password) > Ent]

1> Al arm set	5> Ti me	9> Si li con
2> Modul e conf.	6> Si te	
3> Battery	7> Password #1	
4> Charge	8> Servi ce	

Figure 210: Setup menu

2. Using the arrow keys, set the date and time, and then press **Ent**:

[Main Menu > SETUP > (password) > Time]

Set real time					
Year	Month	Day	Hour	Min	Sec
2011	09	30	23	58	00

Figure 211: Set date and time

8.11.3 Setting the Site Number

1. Select **Site**:

[Main Menu > SETUP > (password) > Ent]

1> Al arm set	5> Ti me	9> Si li con
2> Modul e conf.	6> Si te	
3> Battery	7> Password #1	
4> Charge	8> Servi ce	

Figure 212: Setup menu

2. Use the arrow keys to set the site number, and then press **Ent**:

[Main Menu > SETUP > (password) > Site]

Si te number: 013271

Figure 213: Set site number

Note: The serial number of Power+ is on a bar-code label at the bottom of the unit, on the left hand side.

8.11.4 Changing the Password

1. Select **Password #1**:

[Main Menu > SETUP > (password) > Ent]

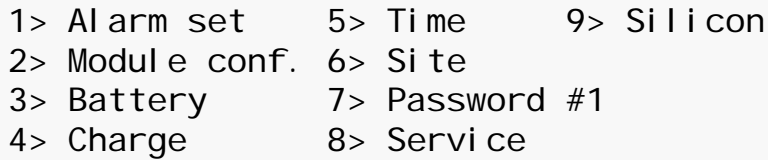

1> Al arm set 5> Ti me 9> Si l i con
2> Modul e conf. 6> Si te
3> Batt ery 7> Passw ord #1
4> Char ge 8> Servi ce

Figure 214: Setup menu

2. Use the arrow keys to change the password and press **Ent**, or press **Esc** to abort:

[Main Menu > SETUP > (password) > Password #1]

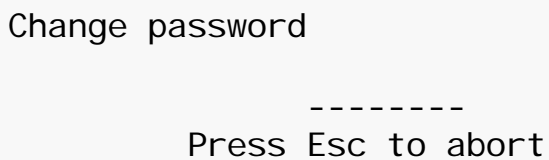

Change password

Press Esc to abort

Figure 215: Change password

8.12 "Setup – "Service" Option

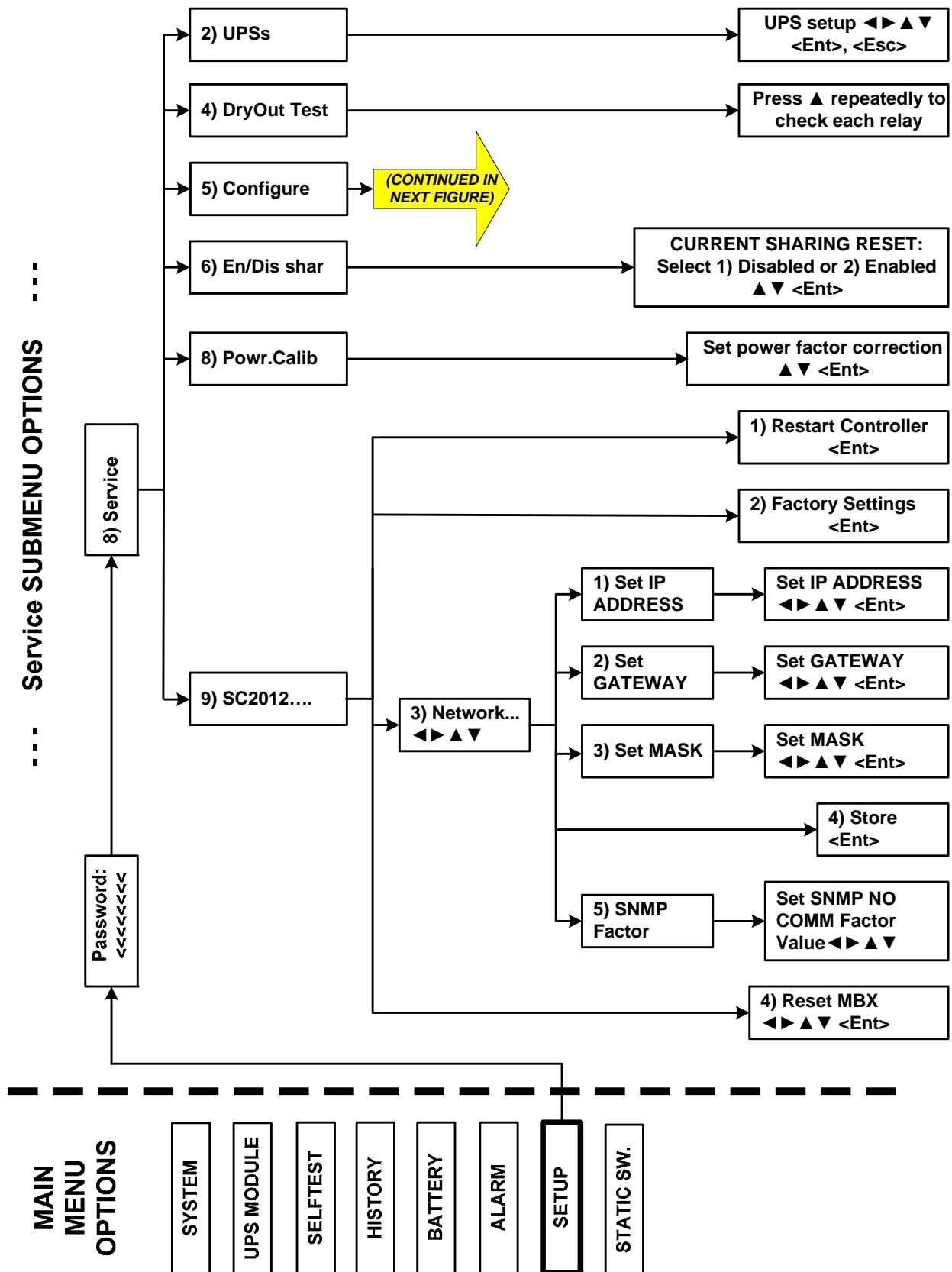

Figure 216: Main Menu option 7 ("Setup – Service") 1/2

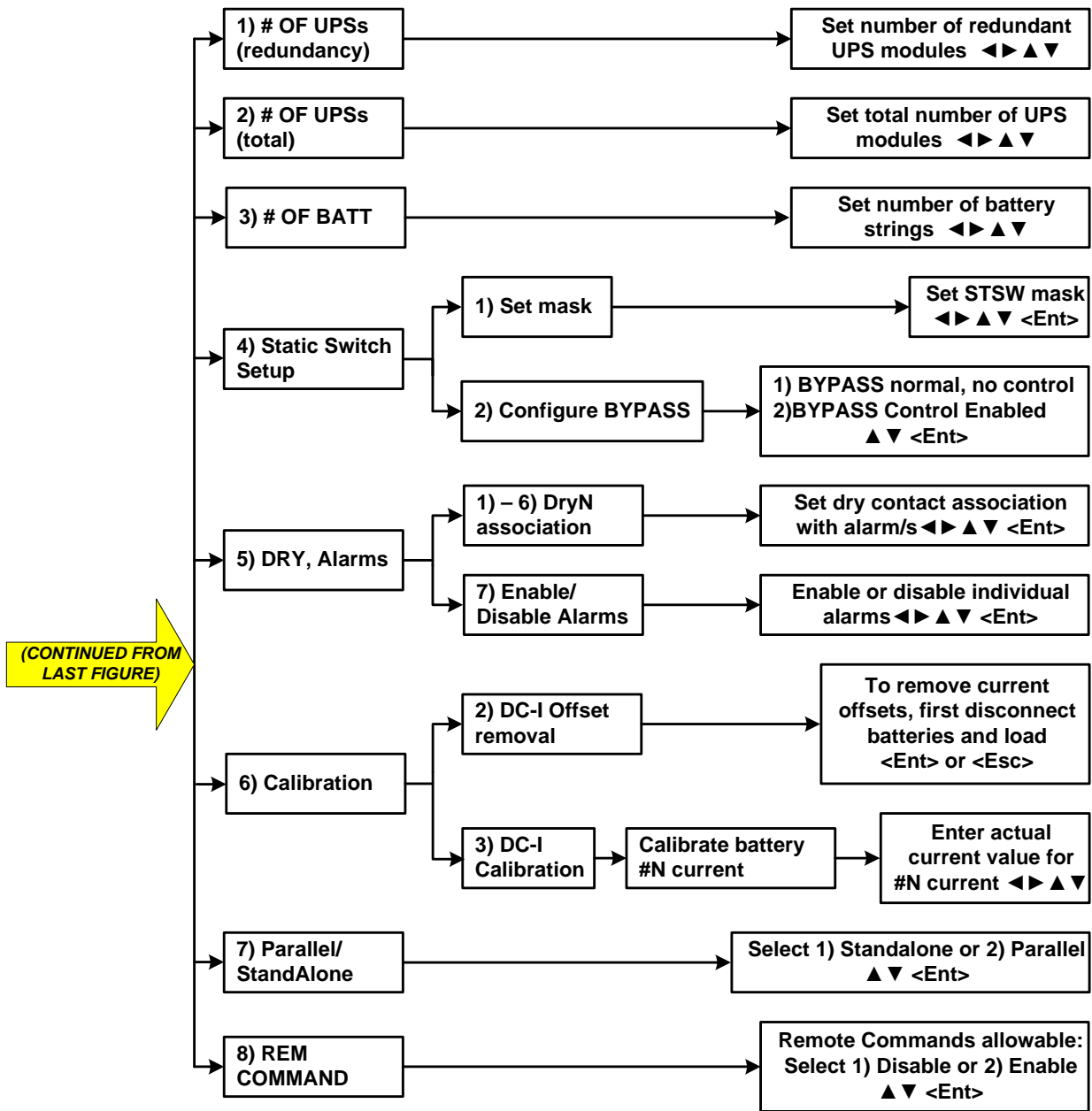

Figure 217: Main Menu option 7 ("Setup – Service") 2/2

- To enter Setup, use the default password <<<<<<<<< (left arrow key eight times).

[Main Menu > SETUP]

```

    POWER+ System Setup
    Type in Level -1 PASSWORD, THEN - ENTER
    Your privilege will expire after 15 mi.n.
    PASSWORD: _____
  
```

Figure 218: Level 1 password access

2. Select **Service**:

[Main Menu > SETUP > (password) > Ent]

```

1> Al arm set      5> Ti me        9> Si li con
2> Modul e conf.  6> Si te
3> Batt ery       7> Pass word #1
4> Char ge        8> Servi ce

```

Figure 219: Setup menu

8.12.1 Setting UPSs

1. Select **UPSs**:

[Main Menu > SETUP > (password) > Ent > Service]

```

1> -----  4> DryOut Test  7> -----
2> UPSs     5> Conf igure   8> Powr. Cal i b
3> -----  6> En/Di s shar  9> SC2012. .
Select, then Enter

```

Figure 220: Service menu

2. Use the arrow keys to set UPSs, and press **Esc** when finished:

[Main Menu > SETUP > (password) > Ent > Service > UPSs]

```

1234
++++
SET UPSs   (UP= ON<+>, DOWN= OFF<->)
Enter =   Execute           Esc= Go back

```

Figure 221: Set UPSs

8.12.2 Testing Dry Output Relays

1. Select **DryOut Test**:

[Main Menu > SETUP > (password) > Ent > Service]

```

1> -----  4> DryOut Test  7> -----
2> UPSs     5> Conf igure   8> Powr. Cal i b
3> -----  6> En/Di s shar  9> SC2012. .
Select, then Enter

```

Figure 222: Service menu

2. Press **▲** slowly to test each relay, and press **Esc** when finished:

[Main Menu > SETUP > (password) > Ent > Service > DryOut Test]

```
Relay status:
Press 'UP' and repeat for relay test(04)
123456                Contacts 1-6
●○○○○○                ●=ON,   ○=OFF
```

Figure 223: Set UPSs

8.12.3 Configuring the UPS

1. Select **Configure**:

[Main Menu > SETUP > (password) > Ent > Service]

```
1> ----- 4> DryOut Test 7> -----
2> UPSs     5> Configure   8> Powr. Cal i b
3> ----- 6> En/Di s shar 9> SC2012. .
Select, then Enter
```

Figure 224: Service menu

8.12.3.1 Number of Redundant UPSs

1. Select **# OF UPSs (redundancy)**:

[Main Menu > SETUP > (password) > Ent > Service > Configure]

```
1> # OF UPSs (redundancy) 5> Dry, Al arms
2> # OF UPSs (total)      6> Cal i brati on
3> # OF BATT              7> Paral lel /StandAl one
4> Static Swi tch Setup   8> REM COMMAND
```

Figure 225: Service > Configure menu

2. Use the arrow keys to set the number of redundant UPSs and then press **Ent**:

[Main Menu > SETUP > (password) > Ent > Service > Configure > # OF UPSs (redundancy)]

```
Set number of UPSs (Redundancy)
```

```
01 (04 total)
```

Figure 226: Set number of redundant UPSs

8.12.3.2 Total Number of UPSs

1. Select **# OF UPSs (total)**:

[Main Menu > SETUP > (password) > Ent > Service > Configure]

```

1> # OF UPSs (redundancy) 5> Dry, Al arms
2> # OF UPSs (total)      6> Cal ibration
3> # OF BATT             7> Paral lel /StandAl one
4> Static Swi tch Setup  8> REM COMMAND
  
```

Figure 227: Service > Configure menu

2. Use the arrow keys to set the total number of UPSs and then press **Ent**:

[Main Menu > SETUP > (password) > Ent > Service > Configure > # OF UPSs (total)]

Set number of UPSs (total)

04 (02 redundant)

Figure 228: Set total number of UPSs

8.12.3.3 Total Number of Batteries

1. Select **# OF BATT**:

[Main Menu > SETUP > (password) > Ent > Service > Configure]

```

1> # OF UPSs (redundancy) 5> Dry, Al arms
2> # OF UPSs (total)      6> Cal ibration
3> # OF BATT             7> Paral lel /StandAl one
4> Static Swi tch Setup  8> REM COMMAND
  
```

Figure 229: Service > Configure menu

2. Use the arrow keys to set the total number of batteries and then press **Ent**:

[Main Menu > SETUP > (password) > Ent > Service > Configure > # OF BATT]

Set Number Of Batteries (0 to 3)

02

Figure 230: Set total number of batteries

8.12.3.4 Setting up the Static Switch

1. Select **Static Switch Setup**:

[Main Menu > SETUP > (password) > Ent > Service > Configure]

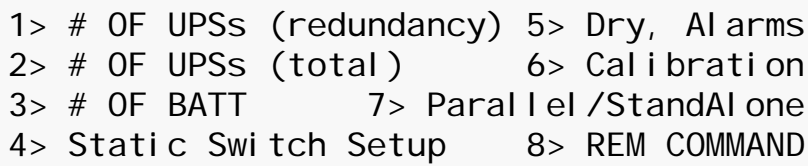

```
1> # OF UPSs (redundancy) 5> Dry, Al arms
2> # OF UPSs (total)      6> Cal i brati on
3> # OF BATT              7> Paral l el /StandAl one
4> Static Swi tch Setup   8> REM COMMAND
```

Figure 231: Service > Configure menu

2. Select **Set mask**:

[Main Menu > SETUP > (password) > Ent > Service > Configure > Static Switch Setup]

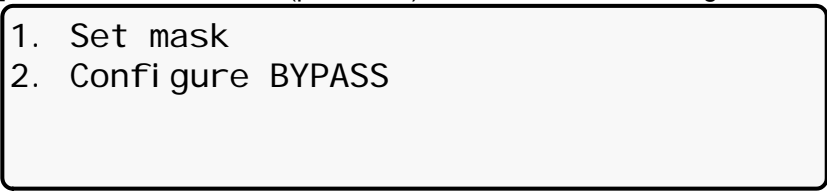

```
1. Set mask
2. Confi gure BYPASS
```

Figure 232: Static Switch setup menu

3. Use arrow keys to set the mask, and then press **Ent**:

[Main Menu > SETUP > (password) > Ent > Service > Configure > Static Switch Setup > Set mask]

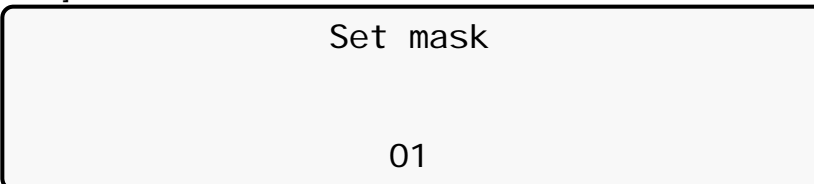

```
Set mask

01
```

Figure 233: Set the mask

4. Select **Configure BYPASS**:

[Main Menu > SETUP > (password) > Ent > Service > Configure > Static Switch Setup]

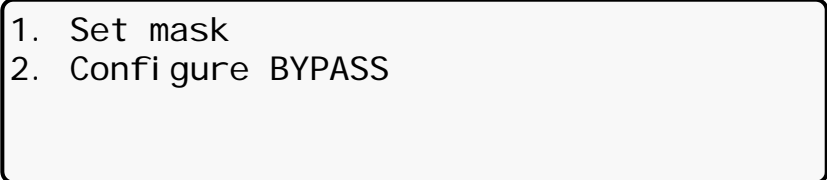

```
1. Set mask
2. Confi gure BYPASS
```

Figure 234: Static Switch setup menu

8.12.3.5 Setting up the Dry Alarms

1. Select **Dry, Alarms**:

[Main Menu > SETUP > (password) > Ent > Service > Configure]

```

1> # OF UPSs (redundancy) 5> Dry, Alarms
2> # OF UPSs (total)      6> Calibration
3> # OF BATT              7> Parallel/StandAlone
4> Static Switch Setup    8> REM COMMAND
  
```

Figure 235: Service > Configure menu

2. Select **DryN Association**:

[Main Menu > SETUP > (password) > Ent > Service > Configure > DRY, Alarms]

```

1> dry1 association 4> dry4 association
2> dry2 association 5> dry5 association
3> dry3 association 6> dry6 association
7> enable / disable alarms
  
```

Figure 236: Dry relay menu

3. Use arrow keys to set associations between dry contacts and alarms, and then press **Ent**:

[Main Menu > SETUP > (password) > Ent > Service > Configure > DRY, Alarms > dry1 association]

```

Associate dry contact #01 with alarm/s
0 0 1 1 2 2 3 3 0=del
1...5...0...5...0...5...0.2 1=add
-----●-----●-----  al m#01
  
```

Figure 237: Set dry contact N alarm associations

4. Use arrow keys to enable or disable alarms, and then press **Ent**:

[Main Menu > SETUP > (password) > Ent > Service > Configure > DRY, Alarms > enable / disable alarms]

```

ENABLE      OR      DI SABLE      ALARMS/s
0 0 1 1 2 2 3 3 0- Di s
1...5...0...5...0...5...0.2 1-Ena
-●●-●-●●●●●●●-●-●●●●●-●●●-  ALM#01
  
```

Figure 238: Enable / disable alarms

8.12.3.6 Calibrating DC Currents

1. Select **Calibration**:

[Main Menu > SETUP > (password) > Ent > Service > Configure]

```
1> # OF UPSs (redundancy) 5> Dry, AI arms
2> # OF UPSs (total)      6> Cal i brati on
3> # OF BATT              7> Paral l el /StandAl one
4> Static Swi tch Setup   8> REM COMMAND
```

Figure 239: Service > Configure menu

2. Select **DC-I Offset removal**:

[Main Menu > SETUP > (password) > Ent > Service > Configure > Calibration]

```
1> ----- 5> -----
2> DC-I Offset removal 6> -----
3> DC-I Cal i brati on 7> -----
4> ----- Select
```

Figure 240: DC-I menu

3. Follow screen instructions:

[Main Menu > SETUP > (password) > Ent > Service > Configure > Calibration > DC-I Offset removal]

```
To remove current offsets,
DISCONNECT BATTERIES and LOAD first,
Then, press ENTER.
Else, press Esc. (0516 0517 0517)
```

Figure 241: Remove current offsets

4. Select **DC-I Calibration**:

[Main Menu > SETUP > (password) > Ent > Service > Configure > Calibration]

```
1> ----- 5> -----
2> DC-I Offset removal 6> -----
3> DC-I Cal i brati on 7> -----
4> ----- Select
```

Figure 242: DC-I menu

5. Press **Ent** to continue:

[Main Menu > SETUP > (password) > Ent > Service > Configure > Calibration > DC-I Calibration]

```
1> Calibrate Battery #1 Current
```

Figure 243: Calibrating DC current

6. Using the arrow keys, set the actual current and then press **Ent**:

[Main Menu > SETUP > (password) > Ent > Service > Configure > Calibration > DC-I Calibration > Ent]

```
CURRENT METER #01 CALIBRATION
Enter the value of the actual current:

02000 (X0.1)A
```

Figure 244: Entering actual current

8.12.3.7 Selecting Standalone or Parallel Operation

1. Select **Parallel/StandAlone**:

[Main Menu > SETUP > (password) > Ent > Service > Configure]

```
1> # OF UPSs (redundancy) 5> Dry, Alarms
2> # OF UPSs (total)      6> Calibration
3> # OF BATT              7> Parallel/StandAlone
4> Static Switch Setup   8> REM COMMAND
```

Figure 245: Service > Configure menu

2. Select **Stand Alone** or **Parallel** by using the ▲▼ arrow keys and **Ent**:

[Main Menu > SETUP > (password) > Ent > Service > Configure > Parallel/StandAlone]

```
--- Parallel / Stand-Alone Setup ---
SELECT - 1: Stand Alone      (selected)
SELECT - 2: Parallel
```

Figure 246: Setting standalone or parallel operation

8.12.3.8 Enabling/Disabling Remote Commands

1. Select **REM COMMAND**:

[Main Menu > SETUP > (password) > Ent > Service > Configure]

```
1> # OF UPSs (redundancy) 5> Dry, Al arms
2> # OF UPSs (total)      6> Calibrati on
3> # OF BATT             7> Paral lel /StandAl one
4> Static Swit ch Setup  8> REM COMMAND
```

Figure 247: Service > Configure menu

2. Enable or disable remote commands by using the ▲▼ arrow keys and **Ent**::

[Main Menu > SETUP > (password) > Ent > Service > Configure > REM COMMAND]

```
--- REMOTE COMMANDS EN / DIS ---
SELECT - 1: Di sabl e          (sel ected)
SELECT - 2: Enabl e
```

Figure 248: Enabling/disabling remote commands

8.12.4 Enabling/Disabling Current Sharing

1. Select **En/Dis shar**:

[Main Menu > SETUP > (password) > Ent > Service]

```
1> ----- 4> DryOut Test 7> -----
2> UPSs     5> Configure  8> Powr. Cal i b
3> ----- 6> En/Di s shar 9> SC2012. .
Select, then Enter
```

Figure 249: Service menu

2. Enable or disable current sharing by using the ▲▼ arrow keys and **Ent**::

[Main Menu > SETUP > (password) > Ent > Service > Configure > En/Dis shar]

```
SELECT 1: RST CURRSHAR DISBLD: (sel ected)
SELECT 2: RST CURRSHAR ENBLD:

--- CURRENT SHARI N RESET EN / DIS ---
```

Figure 250: Enabling/disabling current sharing

8.12.5 Setting Power Factor Correction

1. Select **Powr.Calib**:

[Main Menu > SETUP > (password) > Ent > Service]

```
1> ----- 4> DryOut Test 7> -----
2> UPSs    5> Configure  8> Powr. Cal i b
3> ----- 6> En/Di s shar 9> SC2012..
Select, then Enter
```

Figure 251: Service menu

2. Enable or disable power factor correction by using the ▲▼arrow keys and **Ent**::

[Main Menu > SETUP > (password) > Ent > Service > Configure > Powr.Calib]

```
-- Set power correcti on factor value --
Current Value:      01%
Value to modi fy:  02%
----- Use Up/down, Enter Or Esc -----
```

Figure 252: Enabling/disabling power factor correction

8.12.6 Setting the SC2012

1. Select **SC2012**:

[Main Menu > SETUP > (password) > Ent > Service]

```
1> ----- 4> DryOut Test 7> -----
2> UPSs    5> Configure  8> Powr. Cal i b
3> ----- 6> En/Di s shar 9> SC2012..
Select, then Enter
```

Figure 253: Service menu

2. Select **Restart controller**:

[Main Menu > SETUP > (password) > Ent > Service > SC2012]

```
1> Restart controller 3> Network...
2> Factory settings  4> Reset MBX
Your selection: 1    5> -----
Enter if you are sure (else press Esc.!)
```

Figure 254: SC2012 menu

A confirmation screen appears briefly and the controller restarts.

3. Select **Factory settings**:

[Main Menu > SETUP > (password) > Ent > Service > SC2012]

```
1> Restart controller 3> Network...
2> Factory settings 4> Reset MBX
Your selection: 1 5> -----
Enter if you are sure (else press Esc.!)
```

Figure 255: SC2012 menu

Default settings are implemented, a confirmation screen appears briefly and then the controller restarts.

4. Select **Network**:

[Main Menu > SETUP > (password) > Ent > Service > SC2012]

```
1> Restart controller 3> Network...
2> Factory settings 4> Reset MBX
Your selection: 1 5> -----
Enter if you are sure (else press Esc.!)
```

Figure 256: SC2012 menu

5. Select **Set IP ADDRESS**:

[Main Menu > SETUP > (password) > Ent > Service > SC2012 > Network]

```
1> Set IP ADDRESS 157. 211. 000. 253
2> Set GATEWAY 157. 211. 000. 251
3> Set MASK 255. 255. 255. 000
4> Store 5> SNMP factor Select: 1
```

Figure 257: Network menu

6. Use the arrows keys to set an IP address and press **Ent**:

[Main Menu > SETUP > (password) > Ent > Service > SC2012 > Network > Set IP ADDRESS]

```
Set IP ADDRESS

157. 211. 000. 252
```

Figure 258: Setting an IP address

7. Select **GATEWAY**:

[Main Menu > SETUP > (password) > Ent > Service > SC2012 > Network]

```
1> Set IP ADDRESS      157. 211. 000. 253
2> Set GATEWAY         157. 211. 000. 251
3> Set MASK            255. 255. 255. 000
4> Store      5> SNMP factor   Select: 1
```

Figure 259: Network menu

8. Use the arrows keys to set the gateway and press **Ent**:

[Main Menu > SETUP > (password) > Ent > Service > SC2012 > Network > Set GATEWAY]

```
Set GATEWAY
      157. 211. 000. 251
```

Figure 260: Setting the gateway

9. Select **MASK**:

[Main Menu > SETUP > (password) > Ent > Service > SC2012 > Network]

```
1> Set IP ADDRESS      157. 211. 000. 253
2> Set GATEWAY         157. 211. 000. 251
3> Set MASK            255. 255. 255. 000
4> Store      5> SNMP factor   Select: 1
```

Figure 261: Network menu

10. Use the arrows keys to set the mask and press **Ent**:

[Main Menu > SETUP > (password) > Ent > Service > SC2012 > Network > Set MASK]

```
Set MASK
      255. 255. 255. 000
```

Figure 262: Setting the mask

11. Select **Store**:

[Main Menu > SETUP > (password) > Ent > Service > SC2012 > Network]

```
1> Set IP ADDRESS      157. 211. 000. 253
2> Set GATEWAY        157. 211. 000. 251
3> Set MASK           255. 255. 255. 000
4> Store      5> SNMP factor   Select: 1
```

Figure 263: Network menu

Entered information is stored.

12. Select **SNMP factor**:

[Main Menu > SETUP > (password) > Ent > Service > SC2012 > Network]

```
1> Set IP ADDRESS      157. 211. 000. 253
2> Set GATEWAY        157. 211. 000. 251
3> Set MASK           255. 255. 255. 000
4> Store      5> SNMP factor   Select: 1
```

Figure 264: Network menu

13. Use the arrows keys to set the SNMP NO COMM Factor, press **Ent** and then **Esc**:

[Main Menu > SETUP > (password) > Ent > Service > SC2012 > Network > SNMP factor]

```
Set SNMP NO COMM Factor Value
      (10 - 99)

      50
```

Figure 265 : Setting the SNMP NO COMM factor

14. Select **Reset MBX**:

[Main Menu > SETUP > (password) > Ent > Service > SC2012 > Reset MBX]

```
1> Restart controller 3> Network...
2> Factory settings  4> Reset MBX
Your selection: 1    5> -----
Enter if you are sure (else press Esc.!)
```

Figure 266: SC2012 menu

The MBX is reset.

8.13 “Setup – “Silicon” Option

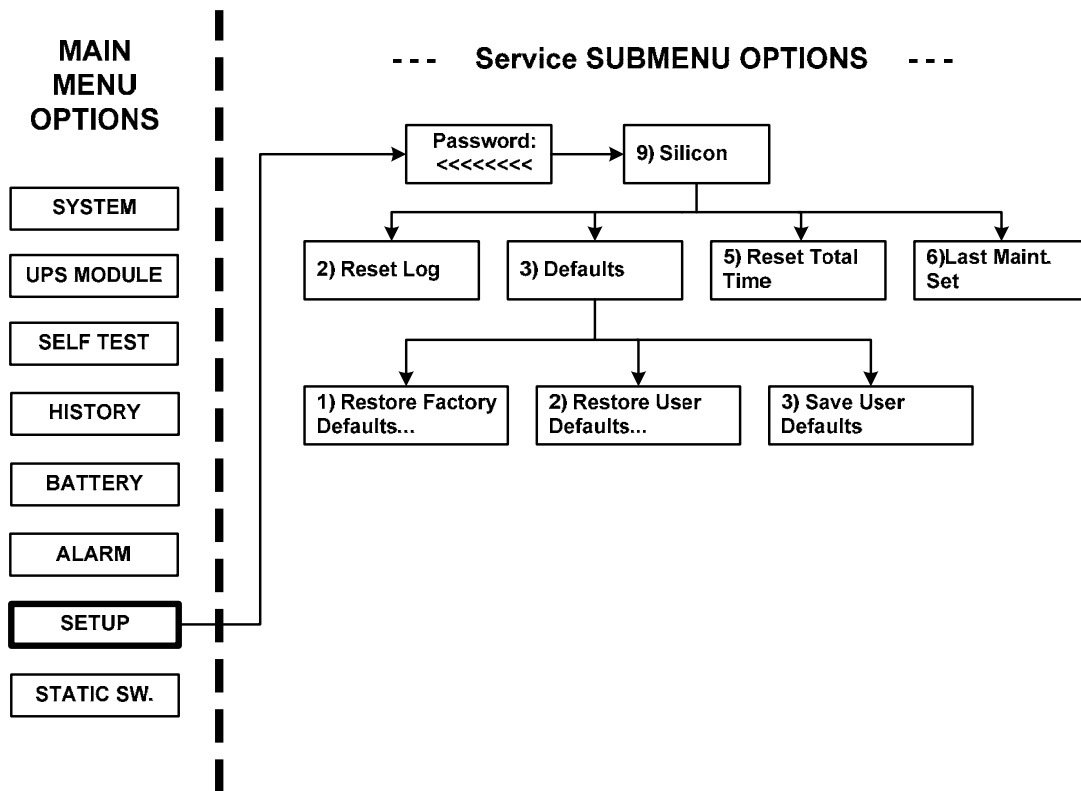

Figure 267 :Main Menu option 7 (“Setup – Static Switch”)

- To enter Setup, use the default password <<<<<<<<< (left arrow key eight times).

[Main Menu > SETUP]

```

POWER+ System Setup
Type in Level -1 PASSWORD, THEN - ENTER
Your privilege will expire after 15 min.
PASSWORD: _____
    
```

Figure 268: Level 1 password access

- Select **Silicon**:

[Main Menu > SETUP > (password) > Ent]

```

1> Alarm set      5> Time          9> Silicon
2> Module conf.  6> Site
3> Battery        7> Password #1
4> Charge         8> Service
    
```

Figure 269: Setup menu

3. Select **Reset Log** and then **Ent** to clear the log:

[Main Menu > SETUP > (password) > Ent > Silicon]

1> -----	5> Reset Total Time
2> Reset Log	6> Last Maint. Set
3> Defaults...	
4> -----	

Figure 270: Silicon menu

4. Select **Defaults...**:

[Main Menu > SETUP > (password) > Ent > Silicon]

1> -----	5> Reset Total Time
2> Reset Log	6> Last Maint. Set
3> Defaults...	
4> -----	

Figure 271: Silicon menu

5. Select **Restore Factory Defaults...**, **Restore User Defaults...**, or **Save User Defaults...**:

[Main Menu > SETUP > (password) > Ent > Silicon > Defaults...]

1> Restore Factory Defaults...	
2> Restore User Defaults...	
3> Save User Defaults...	
Your Selection	3

Figure 272: Silicon defaults

A confirmation screen appears with the option to go back:

Press 'Enter' to proceed OR...
Press 'Esc' to go back

Figure 273: Confirmation screen

6. Select **Reset Total Time** or **Last Maint. Set** if needed:

[Main Menu > SETUP > (password) > Ent > Silicon]

1> -----	5> Reset Total Time
2> Reset Log	6> Last Maint. Set
3> Defaults...	
4> -----	

Figure 274: Silicon menu

8.14 “Static Switch” option

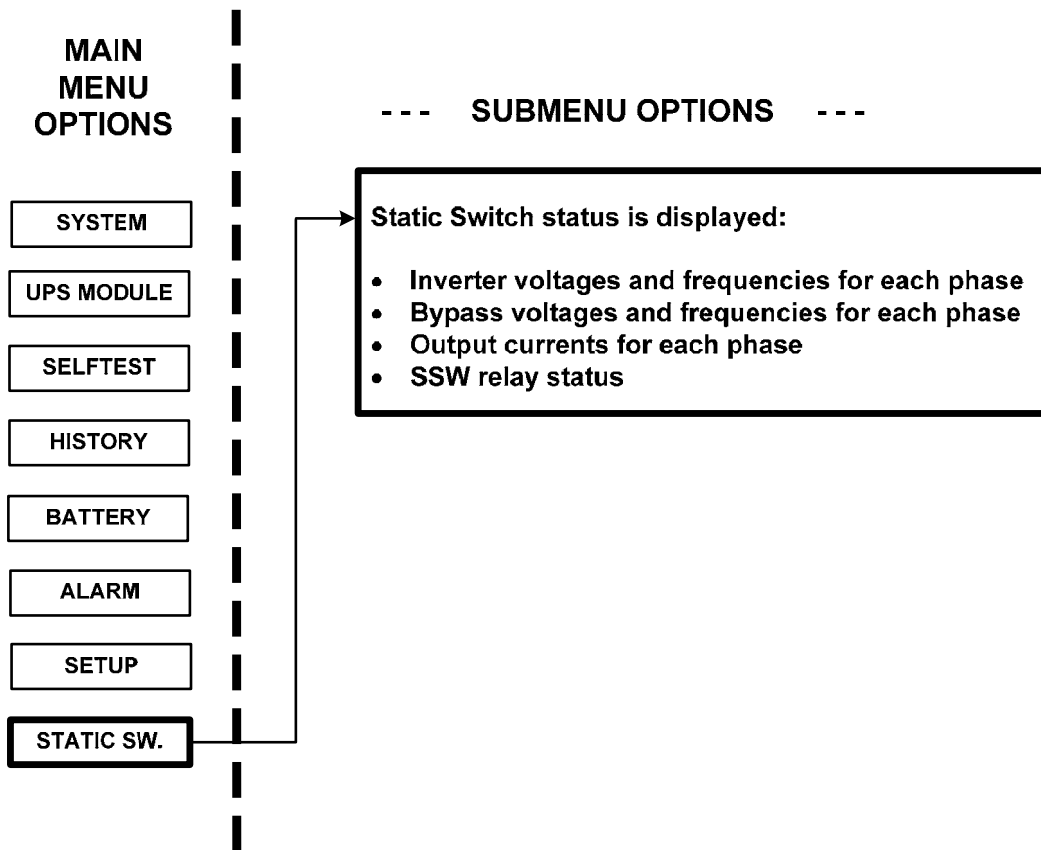

Figure 275: Static switch option

1. View the static switch voltage and frequency:

[Main Menu > STATIC SW]

SSW	VOLTAGE	FREQ
I INVERTER:	L1-120V, L2-120V, L3-120V	60 Hz
BYPASS:	L1-120V, L2-120V, L3-120V	60 Hz
I OUT:	050 050 050	

Figure 276: Static switch voltage and frequency

2. Press ► to view the current messaging status:

[Main Menu > STATIC SW > ►]

M<-----B3----->L	M<-----B4----->L
1 2 3 4 5 6 7 8	9 10 11 12 13 14 15 16
0 0 0 0 0 0 0 0	0 0 0 0 0 0 0 0
SSW STATUS	

Figure 277: Static switch messaging status

8.15 System Controller Setup Verification

The screens described below are useful for verifying system operation after replacing a controller module(s). Especially important are the screens shown under the General section, as shown in Figure 278. This verification procedure is available for software versions beginning from 050106.

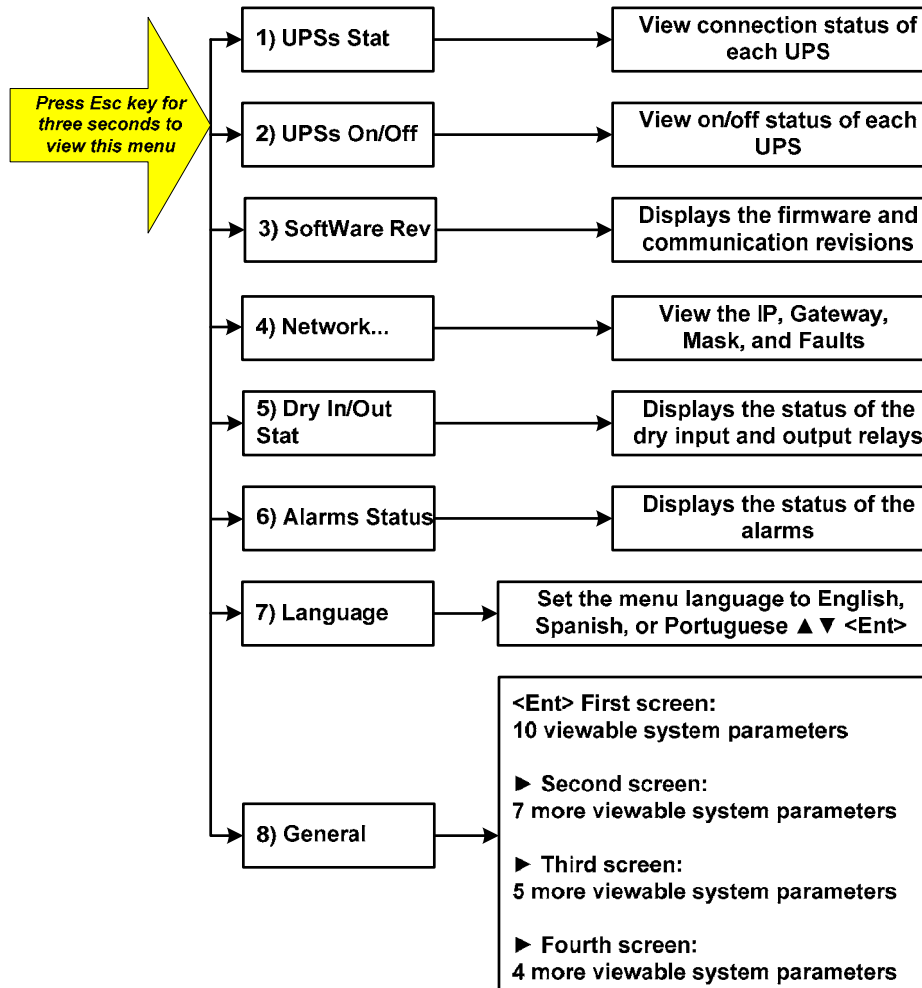

Figure 278: Setup verification screens

8.15.1 Setup Verification Menu

All of the functions listed below are for monitoring purposes only, except for setting the menu language.

[3-second Esc]

1> UPSs Stat	5> Dry In/Out Stat
2> UPSs On/Off	6> Alarms Status
3> SoftWare Rev	7> Language
4> Network. . .	1 8> General

Figure 279: Setup verification menu

8.15.2 Connection Status of UPSs

In the screen shown in Figure 280, UPSs 1 and 2 are connected and UPSs 3 and 4 are not connected. UPSs 5 – 9 are non-existent.

```
[3-second Esc > UPSs Stat]
Stat: 123456789
UPS : ●●○○
```

Figure 280: Connection status of UPSs

8.15.3 On/Off Status of UPSs

In the screen shown in Figure 281, UPSs 1 – 3 are on, UPS 4 is off, and UPSs 5 – 9 are non-existent.

```
[3-second Esc > UPSs On/Off]
Stat: 123456789
UPS : +++-
```

Figure 281: On/Off status of UPSs

8.15.4 Software and Communication Revision

The firmware revision refers to the firmware located on the main Power+ board. The communication revision refers to the communication board revision.

```
[3-second Esc > SoftWare Rev]
F I R M W A R E   R E V :   S C 2 5 0 1 1 2 0 8

C O M M   R E V :           2 5 4 . 1 0 2
```

Figure 282: Software and communication revision

8.15.5 Network Parameters

The network parameters shown below define a specific Power+ unit.

```
[3-second Esc > Network...]
IP          157. 211. 000. 253
Gateway:    157. 211. 000. 251
Mask:       255. 255. 255. 000
Faults:     090, 073
```

Figure 283: Network parameters

8.15.6 Dry Input and Output Relay Contact Status

The input and output contacts for the Power+ are displayed in Figure 284: input relay contacts 1 and 3 are closed and all other contacts are open. The output contacts are generally used to provide external alarms.

```
[3-second Esc > Dry In/Out Stat]
Dry : 12345678
In  : ●●○○○○○○
Out : ○○○○○○
```

Figure 284: Dry input and output relay contact status

8.15.7 Alarms Status

Alarms shown as solid circles are active:

```
[3-second Esc > Alarms Status]
-----System Alarm Status-----
1 ●○○○○○○○○○○○○○○● ●●○○○○●●○○○○●● 32
```

Figure 285: Alarms status

8.15.8 Setting the Menu Language

Select the desired menu language using the ▲ ▼ keys and press **Ent**:

```
[3-second Esc > Language]
-----          LANGUAGE SETUP          -----
SELECT - 1: Engl i sh                    (sel ected)
SELECT - 2: Spani sh
SELECT - 3: Portugese
```

Figure 286: Set menu language

8.15.9 System Parameter Settings

User the arrow keys ▲ ▼ to select General, and then press **Ent**:

```
[3-second Esc]
1> UPSs Stat           5> Dry In/Out Stat
2> UPSs On/Off        6> Al arms Status
3> SoftWare Rev       7> Language
4> Network...         1 8> General
```

Figure 287: Select General

8.15.9.1 First General Screen

A description of the various system parameters shown in screen 1 are listed below.

```
[3-second Esc > GENERAL]
ACV: 120. . . ALM: 242/185    TEMP. ALARM: 45C
MODULES: 07/02    C. LIM= off , T. C= 2. 0mV
DCV: 216. . . ALM: 475/360/340
BATT. . . TEST: 04/05/360/352. . . CAP: 0010 AH
```

Figure 288: General (Screen 1)

- a. **ACV**: nominal value of the input/output ac voltage (220 for 2x32 batteries; 110 for 2x16 batteries).
- b. **ALM**: input ac voltage alarm HIGH/LOW.
- c. **TEMP. ALARM**: high temperature limit for an external temperature sensor.
- d. **MODULES: QUANTITY/REDUNDANCY**: 07/02 in the screen means that 7 modules are presented in the system, 2 modules are reserve (full load is $10\text{ kVA} \times (7-2) = 50\text{ kVA} / 40\text{ kW}$).

- e. **C.LIM.=off (VALUE):** battery current limit function is de-activated (off) or maximum battery current value in Amps. If C.LIM is activated, the system must be equipped with an optional battery current sensor.
- f. **T.C. = 2.0mV:** negative temperature coefficient of the battery dc voltage in mV per °C per battery cell. Nominal temperature is 25 °C. For dc nominal voltage 432 V , temperature 35 °C, 32 batteries of 6 cells, T.C.=2 mV, the voltage is $432 - 2 * 6 * 32 * (35 - 25) = 428$ V. NOTE. For most applications, T.C. must be 0 (off).
- g. **DCV:** Dc nominal voltage for both positive and negative battery sets. For 32 batteries in the set DCV=432 V, for 16 batteries 216 V.
- h. **DCV ...ALM:** Dc voltage alarms HIGH/LOW/SHUTDOWN. SHUTDOWN alarm is dc voltage value when the unit is stopped due to battery discharge.
- i. **BATT....TEST:** PERIOD IN WEEKS/MAX.DURATION IN HOURS/ALARM VOLTAGE/CHARGER DERATED VOLTAGE. In the screen: the test is performed automatically once per 4 weeks, max. test duration is 5 Hours, if battery voltage drops below 360 V alarm Battery Low is produced, and the chargers for the modules continue to supply a voltage of 352 V to prevent shutdown if battery is faulty.
- j. **CAP:** CAPACITY in Amp-Hours. Used to calculate estimated back-up time of the system and battery test duration.

8.15.9.2 Second General Screen

From the screen shown in the previous section, press ► to view screen 2:

[3-second Esc > GENERAL > ►]

CURRSHARE RST:	DIS	#OF PHASE:	AUTO
REV :	SC25230909	LVD BY AC FAIL:	DIS
MAINT:	2010.05.12	TEMP. SENSOR:	DIS
SITE :	000001	CURR. SENSOR:	DIS

Figure 289: General (Screen 2)

A description of the various system parameters shown in screen 2 are listed below.

- a. **CURRSHARE RST:** displays the status of the current sharing—either enabled or disabled (EN or DIS).
- b. **#OF PHASE:** FORCE 3 for 3-phase output, FORCE 1 for single-phase output or AUTO when the mode is defined by DIP SWITCH of the modules.
- c. **REV:** revision of the system controller (SC) software.
- d. **LVD BY AC FAIL:** DIS (disabled) or EN (enabled). This function, if enabled, performs system shutdown after 3 hours of ac failure to prevent deep battery discharge by low current. For most applications, the function must be disabled.
- e. **MAINT:** YEAR.MONTH.DAY: date of last maintenance.
- f. **TEMP. SENSOR:** DIS or EN. External temperature sensor is disabled/ enabled. In most applications, it must be disabled.
- g. **SITE:** the site identification number is used in network applications.

- h. **CURR.SENSOR:** DIS or EN. Optional battery current sensor is disabled/ enabled. In most applications, it must be disabled.

8.15.9.3 Third General Screen

From the screen shown in the previous section, press ► to view screen 3:

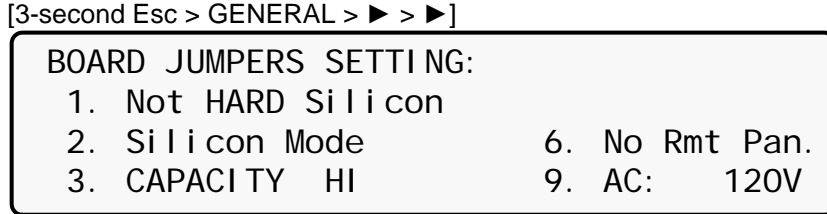

Figure 290: General (Screen 3)

A description of the various system parameters shown in screen 3 are listed below:

- a. **Not HARD Silicon:** Must be HARD only initially, during first activation of non-configured controller. After production, it should be **Not HARD Silicon**.
- b. **Silicon Mode:** Regular mode allowing setup change. The setups are saved in an EEPROM chip.
- c. **CAPACITY HI (LO):** High/low battery capacity mode when battery capacity is more/less than 100 Ah to achieve optimal resolution of the displayed value of battery current.
- d. **No/Yes Rmt Pan:** Outputs of system controller are not configured or configured for an optional remote panel connection.
- e. **AC: 220 V:** Nominal ac input voltage: 220 V for 2x32 batteries, 110 V for 2x16 batteries in series.

8.15.9.4 Fourth General Screen

From the screen shown in the previous section, press ► to view screen 4.

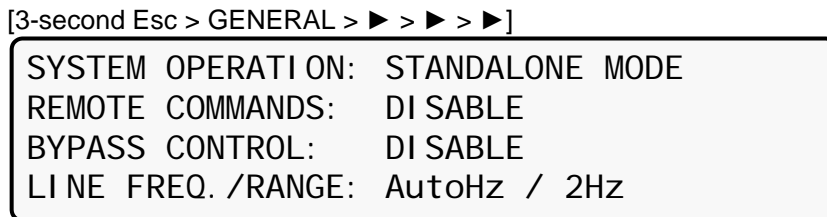

Figure 291: General (Screen 4)

A description of the various system parameters shown in screen 4 are listed below.

- a. **SYSTEM OPERATION:** Indicates either standalone or parallel mode.
- b. **REMOTE COMMANDS:** These commands can be enable or disabled.
- c. **BYPASS CONTROL:** This command can be enabled or disabled.
- d. **LINE FREQ./RANGE:** The line frequency control and its variation range is indicated.

9. THE POWER+ BUILT-IN WEB INTERFACE

The Power+ built-in Web interface enables you to monitor and control the Power+ from a distance, using a PC over an Ethernet network. All that is required is an HTML browser such as Microsoft's Internet Explorer.

9.1 Preliminaries to use of the Web interface

To enable the Power+ Web interface:

1. Consult with your Network Administrator to obtain an IP address for your Power+, and the appropriate mask and gateway address.
2. Configure the Power+ with the IP address. This is done from the Power+ main menu as follows:
 - a. **Setup >** (enter your password, then press **Ent**; default password is 8 left arrows) **> Service > SC2012 > Network.**
 - b. From the Network menu, choose **IP Address** and enter the assigned IP address.
 - c. From the Network menu, choose **Gateway** and enter the assigned Gateway address.
 - d. From the Network menu, choose **Mask** and set the assigned subnet mask.
 - e. From the Network menu, choose **Store** to save the information just entered.
3. Connect the Power+ to the local Ethernet network using the Ethernet (RJ45) port on the rear panel of the Power+ controller. This is the port labeled "TCP/IP Port" on the left side of the controller rear panel in Figure 292 below.



Figure 292: Power+ controller rear panel

4. On a computer terminal that has connectivity to the Power+ IP address, open a Web browser and enter the Power+ IP address in the URL bar. For example, type **//154.102.2.130** and press Enter. You should see the Web interface main screen (see Figure 293 below).

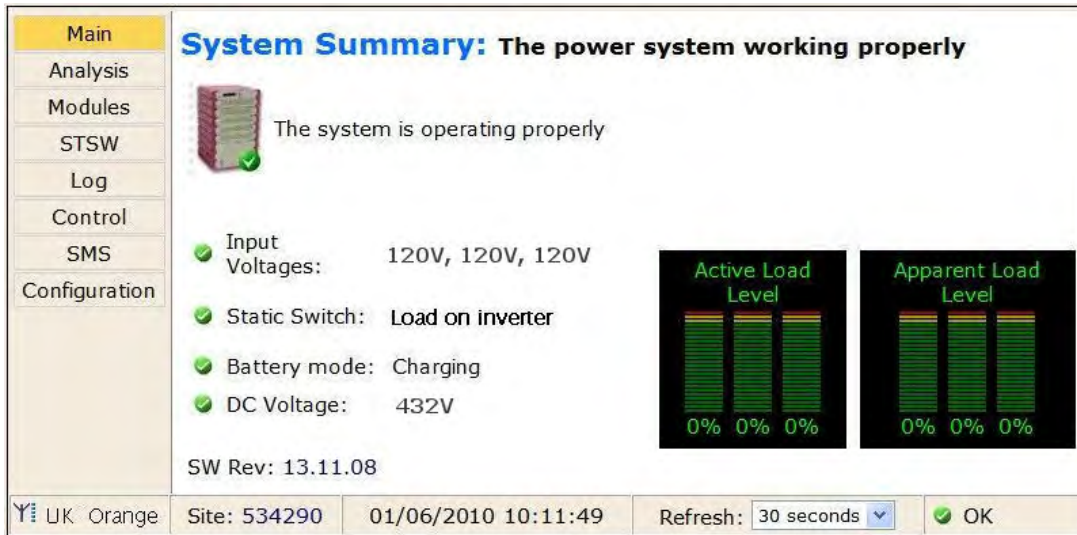

Figure 293: Main Screen of the Power+ Web interface



9.2 Main Screen

The Main Screen (see Figure 293 above) is the first screen you see when connecting to the GMaCi software.

The column on the left side of the screen is the Main Menu. The Main The first option in the Main Menu brings you to the Main Screen when you are not already there.

The items in the rest of the Main Screen are described in Table 14.

Table 14: Main Screen features

ITEM	DESCRIPTION		
System Summary:	Informs you if attention is required or not.		
GSM module status	Cellular (GSM) communication is Available / Not available. A signal-strength indicator is displayed along with the service provider name. Cellular communication requires the Wing module.		
Site number:	The site number is identified.		
Date and time	The current date and time are displayed.		
Refresh:	The time interval at which the display is periodically updated.		
ITEM	DESCRIPTION		
UPS image	–	No active alarms at this time.	One or more alarms are active.
Input voltages	The voltage of each input phase is listed.	All input voltages are within range.	One or more of the input phases has a voltage outside of the permitted range.
Static Switch	Load on: Inverter (checkmark) / Bypass ("x")	Load on inverter.	Load on bypass.
Battery mode:	Charging (checkmark) / Discharging ("x")	Battery charged or charging.	Battery discharging or discharged.
Dc voltage	Current battery / charging voltage (Vdc).	Battery voltage in range.	Battery voltage out of range.

9.3 The Main Menu and its options

The Main Menu of Power+'s built-in remote management software consists of a column of option buttons on the left side of the Main Screen (see Figure 293 on page 139).

Table 2 lists the options in the Main Menu column on the Main Screen, and describes each option briefly. Each option is described in greater detail in the subsequent sections.

Table 15: Main Menu options

MENU OPTION	DESCRIPTION
Main	Displays a condensed system status: Alarm status and basic readings.
Analysis	Shows real-time readings for each input and output phase: voltage, current, kVA, kW, and power factor.
Modules	Displays status of individual UPS modules, shows input and output ac voltages and currents, dc voltage, and active alarms if any.
STSW	Displays status of Static Switch, including inverter output voltages and frequency, bypass voltages and frequency, and active alarms if any.
Log	Displays system log; data can be printed or exported to an Excel file.
Control	<p>From this screen, the following system commands can be executed: Move load to bypass, move load to inverter, start battery test, abort battery test, LEDs test, shutdown, startup, restart, simulate load on battery condition, simulate battery status is low.</p> <p>Use of this option is disabled by factory default. To enable (or disable), from the Power+ console main menu choose the following: (7) Setup > (8) Service > (5) Config > (8) Rem Command</p>
SMS	View received or sent SMS Messages in this screen from this screen (Wing module must be present). Click Available SMS commands to send an SMS message.
Configuration	Configure the settings of the remote management software.

The Main Menu options are described in more detail below.

9.3.1 “Analysis” main menu option

The main menu’s “Analysis” option lists current values for voltage, current, apparent power (kVA), active power (kW), and power factor, for each input and output phase.

Main	Input					
Analysis		Voltage	Current	Apparent Power	Active Power	Pf
Modules	Line 1	121V	2A	0.2KVA	0.2KW	1.00
STSW	Line 2	123V	2A	0.2KVA	0.2KW	1.00
Log	Line 3	122V	2A	0.2KVA	0.2KW	1.00
Control	Summary			0.6KVA	0.6KW	
SMS	Output					
Configuration		Voltage	Current	Apparent Power	Active Power	Pf
	Line 1	120V	4A	0.4KVA	0.0KW	0.00
	Line 2	120V	2A	0.2KVA	0.0KW	0.00
	Line 3	120V	0A	0.0KVA	0.0KW	0.00
	Summary			0.6KVA	0.0KW	

Figure 294: Analysis of system input and output voltages and power

9.3.2 “Modules” main menu option

The “Modules” main menu option enables you to see readings for an individual UPS module. To see the readings for a particular module, click on the correspondingly numbered image of the UPS module.

Main	Module #1		
Modules		Status <ul style="list-style-type: none"> ✔ UPS On ✔ Input relay On ✔ Precharge relay On ✔ Output relay On ✔ Load is normal ✔ PFC On ✔ Inverter On ✔ UPS is in master mode ✔ Inverter is synchronized ✔ Shutdown is not performed ✔ Input voltage OK ✔ Output voltage OK 	AC Input Line 1: 123V 0A Line 2: 126V 0A Line 3: 123V 0A AC Output Line 1: 120V 2A Line 2: 120V 2A Line 3: 120V 0A DC Voltage Positive: 220V Negative: 216V Total: 436V
STSW			
Log			
Control			
SMS			
Configuration			

Figure 295: Modules measurements and status display

9.3.3 “STSW” (Static Switch) main menu option

The “STSW” (Static Switch) option on the main menu displays the real-time voltage and frequency measurements for the inverter output voltage and the bypass voltage. This screen also displays a wealth of additional information about the status of the Static Switch, as can be seen in Figure 296.

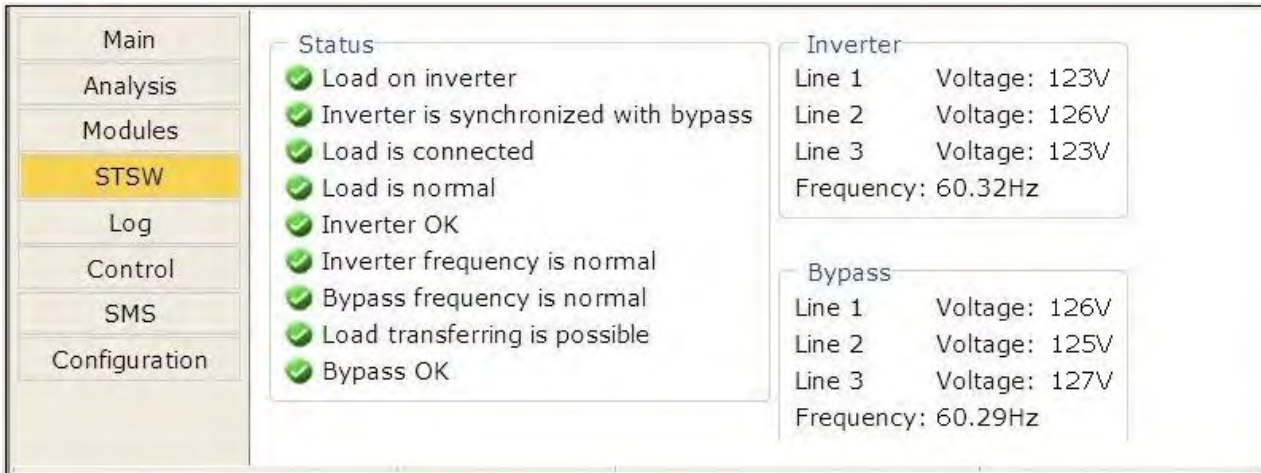

Figure 296: Static Switch data and status display

9.3.4 “Log” main menu option

Main						
Analysis	Id	In/Out	Entry	Alarm	Description	VDC
Modules	1	In	25/04/2010 12:58:44	BAT-CB	Battery Circuit Breaker is open	432
STSW	2	In	25/04/2010 12:57:52	STRTUP	Startup time-stamp	0
Log	3	In	15/04/2010 09:41:18	BAT-CB	Battery Circuit Breaker is open	433
Control	4	In	15/04/2010 09:40:20	STRTUP	Startup time-stamp	0
SMS	5	Out	14/04/2010 15:05:10	LOADBP	Load on BYPASS	0
Configuration	6	Out	14/04/2010 15:04:40	UPSMAJ	UPS modules Warning!	0
	7	Out	14/04/2010 15:04:36	STSWRN	Static Switch Warning	433
	8	Out	14/04/2010 15:04:22	UPSHDN	UPS Shut Down	435
	9	In	14/04/2010 14:59:58	STSWRN	Static Switch Warning	434
	10	In	14/04/2010 14:59:56	UPSMAJ	UPS modules Warning!	1
	11	In	14/04/2010 14:59:26	LOADBP	Load on BYPASS	64
	12	In	14/04/2010 14:59:22	UPSHDN	UPS Shut Down	432
Total items in log: 252						
Printable version Export to Excel						

Figure 297: Listing the log entries

Table 16: Data items on the event log screen

MENU OPTION	DESCRIPTION
ID	This is simply a line number.
In / Out	“In” indicates the start of an alarm condition. “Out” indicates the end of an alarm condition.
Entry	Timestamp in the format dd/mm/yyyy hh/mm/ss
Alarm	Alarm code.
Description	Alarm message. See Table 17.
VDC	Battery voltage.

Table 17: Alarm message text in Web interface log display

(Use the alarm number in this table to reference Table 12 on page 77 for a fuller explanation of the alarm condition.)

LOG MESSAGES, IN ALPHABETICAL ORDER	ALARM NO.
"AC Input Failure"	22
"AC Input high"	21
"An alarm/s is vibrating"	6
"Battery Circuit Breaker is open"	25
"Communication lost"	0
"Communication lost"	32
"Emergency Power Off Activated"	14
"End of Backup"	11
"Equalizing mode"	15
"HIGH Battery voltage"	9
"Input Brownout"	20
"Last battery test"	16
"Last self test fail"	24
"Load current high"	29
"Load on BYPASS"	5
"Low Battery voltage"	12
"N.A."	3
"N.A."	4
"N.A."	10
"No AC output to load"	8
"One UPS module Warning!"	2
"Over temperature"	7
"Startup time-stamp"	31
"Static Switch Warning"	13
"STSW Not responding"	23
"Suspect a fault output stage"	27
"Suspect fault current sharing"	26
"UPS modules Warning!"	1
"UPS or more not responding"	30
"UPS Shut Down"	28
"User 1 input open"	17
"User 2 input open"	18
"User 3 input open"	19

9.3.5 “Control” main menu option

The “Control” main menu option enables the user to initiate any of a number of UPS processes. The commands available are described in Table 18 below .

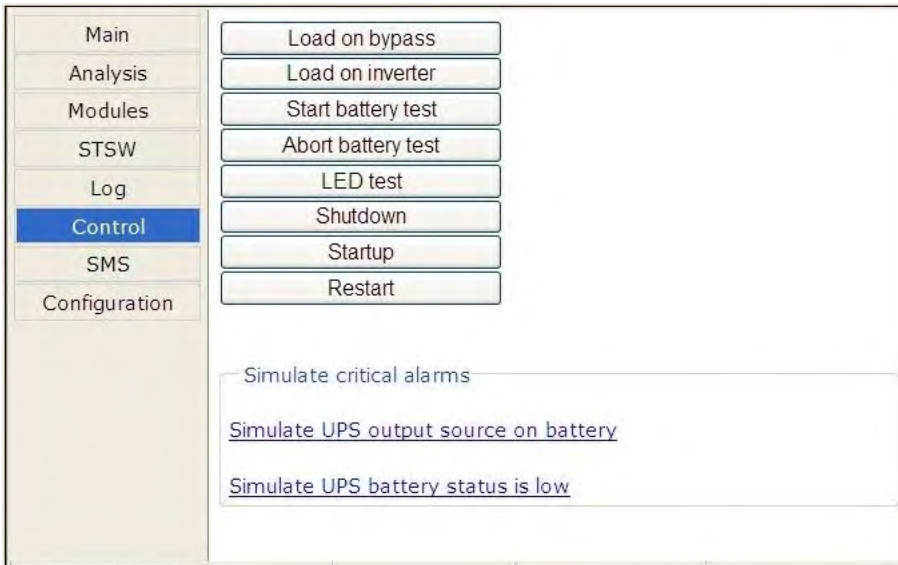

Figure 298: The "Control" main menu option screen

Table 18: Commands available on the “Control” screen

MENU OPTION	DESCRIPTION
Load on bypass	Transfers the load to the bypass voltage.
Load on inverter	Transfers the load to the inverter.
Start battery test	Initiates a battery test. Note: it is recommended that a battery test not be initiated when the when the UPS is operating near 100 % capacity and at the same time the battery is known to be not fully charged or not connected or otherwise faulty.
Abort battery test	Stop a battery test immediately.
LED test	The UPS beeps briefly and all of the LEDs on the control panel light up, to reveal any faulty LEDs.
Shutdown	Shuts down the Power+. Power will continue to be available to the loads from the bypass voltage.
Startup	Starts up the Power+ when it is in an “OFF” condition.
Restart	When the Power+ is “ON”, this command initiates a shutdown of the Power+ followed by a startup.

At the bottom of the “Control” screen are two links:

Simulate UPS output source on battery: clicking on this link simulates the conditions in effect during an ac power failure –a signal is sent via SNMP to any connected computers informing them of an ac power failure (in actuality, the load continues to be supplied from the inverter). If the computers are configured for automatic shutdown on ac power failure, they begin their shutdown countdown. This option is useful for testing the auto-shutdown configuration on a computer. The simulation can be ended by the user at will. If the countdown continues to completion, the designated shutdown targets (see section 9.3.7.6 on page 151) **will be shut down!**

Simulate UPS battery status is low: clicking on this link simulates the conditions in effect after an extended ac power failure –a signal is sent via SNMP to any connected computers informing them of a “low battery condition” (actually non-existent). If the computers are configured for automatic shutdown on low battery, they begin their shutdown countdown. This option is useful for testing the auto-shutdown configuration on a computer. The simulation can be ended by the user at will.

Warning: The low-battery countdown is configured in seconds, so computer shutdown will occur relatively quickly.

9.3.6 “SMS” main menu option

On Power+ units equipped with the optional GSM cellular communications module, the “SMS” main menu option enables the controller to send an SMS message to any cellular telephone, and review all received or sent SMS messages. Messages are automatic; they cannot be created by the user.

Figure 299: “SMS” screen

9.3.7 “Configuration” main menu option

Choosing the “Configuration” option on the Web interface’s main menu displays the Configuration (sub) menu. Through this menu, various important UPS settings can be modified. The options in the Configuration menu are described below.

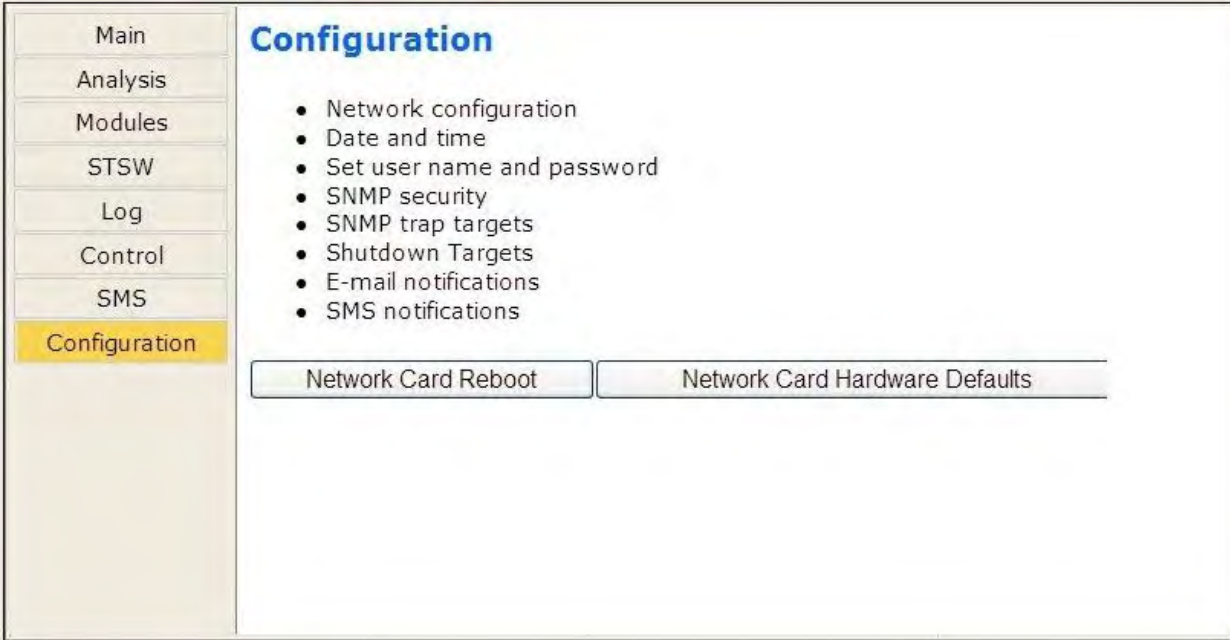

Figure 300: Configuration menu

Selecting any of the options in the Configuration menu causes the Web interface to prompt for a user-ID and password. The factory default user-ID is **admin**, and the factory-default password is also **admin**. These default values for the user-ID and password can be changed, as is explained below in section 9.3.7.3 on page 149.

After entering the correct user-ID and password and then pressing Enter, the requested screen is displayed.

The user-ID and password are only requested once per session, on the first entry into any of the Configuration menu options.

Warning: When an IP address or addresses are specified for a given community, only the specified addresses have access to the community. All other users will be shut out from the defined community.

9.3.7.1 Network configuration

The “Network configuration” option on the Configuration menu is equivalent to navigating to **Setup > Service > SC2012 > Network** on the Power+ physical control panel. Here you define the parameters needed to communicate with the Power+ over an intranet or over the Internet. Consult your local network administrator for the proper IP address, subnet mask, and Gateway address.



Figure 301: Configuring network communication parameters

9.3.7.2 “Date and time” – setting the calendar and clock

The “Date and time” option on the Configuration submenu is used to set the date and time of the Power+ internal calendar and clock. The date and time settings are important, for they are used to timestamp entries in the Power+ log.

The date and time are kept current by the Power+, including when the system is in the “off” state.

Click the Back button to return to the Configuration menu.



Figure 302: Setting the Power+ internal date and time

9.3.7.3 Set user name and password

The “Set user name and password” on the Configuration submenu enables you to change the user-ID and password used for entry into the options on the Web interface’s Configuration submenu.

The factory default user-ID and password are **admin** and **admin**. The new user-ID and password must each have a minimum of four characters and up to a maximum of nine characters. If entered, the new user-ID and password are effective immediately.

Click the Back button to return to the Configuration submenu.



The screenshot shows a web interface for configuring the user name and password. On the left is a vertical navigation menu with the following items: Main, Analysis, Modules, STSW, Log, Control, SMS, and Configuration. The 'Configuration' item is selected. The main content area is titled 'User name and password' in blue. It contains three text input fields: 'New user name:', 'New password:', and 'Confirm new password:'. Below these fields are three buttons: 'Apply', 'Reset', and 'Back'. To the right of the input fields, there is a yellow warning icon and the text: 'User name and password must be at least 4 and up to 9 characters.'

Figure 303: Changing username and password of the Web interface

9.3.7.4 SNMP security

The SNMP security screen is where you define the SNMP communities that will have access to the Power+, and whether that access will be “read only” (requests for data – a “read-only”) or “read-write” (includes the ability to modify G4 settings).

You also have the capability of limiting the IP addresses from which the G4 will accept SNMP packets. If the IP address has 4 segments of zero (0.0.0.0), this means that all users in the community will have the designated access.

Community	Rights	
<input type="text"/>	READ ONLY	<input type="button" value="Add"/>
public	READ ONLY	remove
private	READ WRITE	remove

Accept SNMP packets from any host

Accept SNMP packets from these hosts

Figure 304: Define SNMP permissions

9.3.7.5 SNMP trap targets

An SNMP trap is a destination to which the G4 will send alarm notifications using the SNMP protocol. For each destination, an IP address and a port must be specified.

IP address	Port
<input type="text"/>	162
<input type="text"/>	162
<input type="text"/>	162
<input type="text"/>	162
<input type="text"/>	162
<input type="text"/>	162
<input type="text"/>	162
<input type="text"/>	162
<input type="text"/>	162
<input type="text"/>	162

Figure 305: Defining SNMP trap targets

9.3.7.6 Shutdown Targets

The “Shutdown Targets” option of the Configuration menu is where you record the IP address of the computers that you want to have an orderly shutdown performed in the event of an ac mains power outage.

To use this option, the computer in question must have a Shutdown Agent installed on it. The Shutdown Agent is available as a self-installing “setup.exe” file intended to be run on the target computer. The install file can be downloaded from the Internet by clicking on the “Shutdown Agent” link in the bottom right of the screen as shown in Figure 306.

Note: The built-in Web interface supports a maximum of 15 shutdown targets. Customers requiring a larger number of shutdown targets should inquire about the PSM-AC for Power+ software product (see section 10 on page 155).

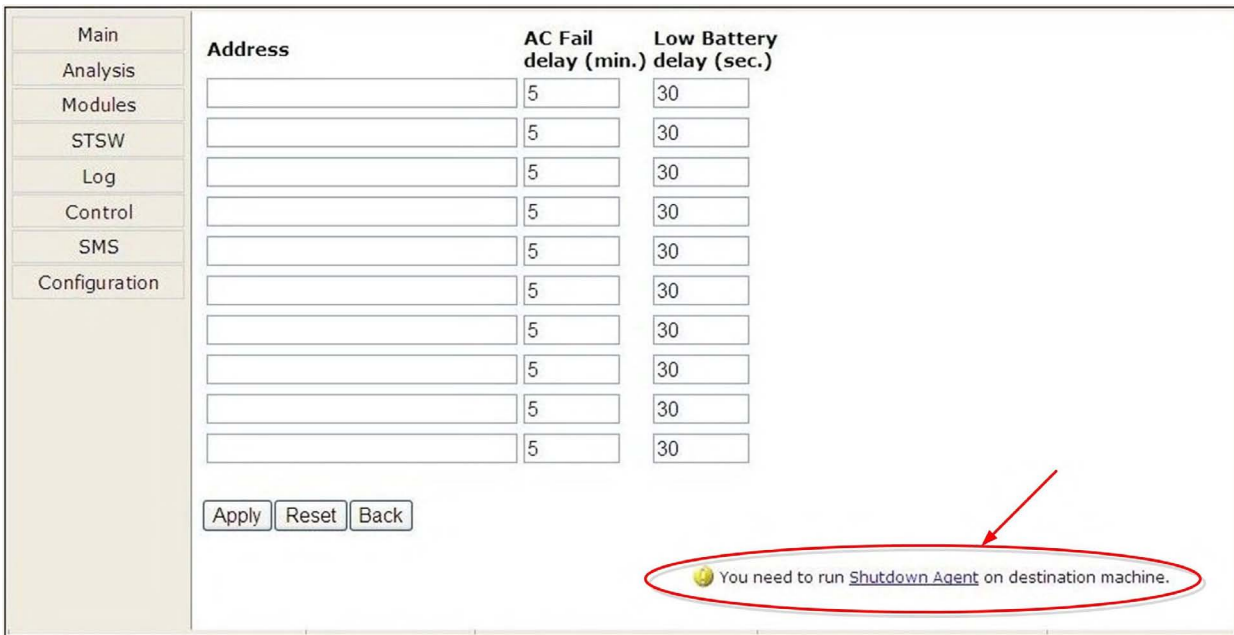

Figure 306: Define computers for auto-shutdown

Table 19: Defining computers for auto-shutdown

FIELD	DESCRIPTION
Address	IP address of the computer to be automatically shut down in the event of a power failure.
Ac Fail delay (minutes)	Delay in minutes between ac failure and initiation of the automatic shutdown.
Low Battery delay (seconds)	Delay in seconds between low-battery alarm and initiation of the automatic shutdown.

HOW AUTO-SHUTDOWN WORKS:

In the event of an ac power mains failure, the Power+ sends a notification to the IP addresses defined in the PC notification and shutdown screen. This generates a pop-up message on the computer screen advising of the ac fail condition, and starts a countdown. The countdown for each computer lasts for the number of minutes specified in the “Ac fail delay” field. If this countdown is exhausted before ac power returns, the Shutdown Agent saves and closes any open datasets on the computer and then shuts the computer down.

If during the countdown, the Power+ battery falls below a preset voltage (the low-battery voltage threshold, defined via the Power+ controller), the Power+ notifies the defined computers of the low-battery condition. This starts another countdown, that lasts for the number of seconds defined in the “Low battery delay” field and also cancels any other active shutdown countdown. When this latest countdown is exhausted, the Shutdown Agent saves and closes any open datasets on the computer and then shuts the computer down. This takes place even if the “Ac fail delay” countdown was not yet finished.

9.3.7.7 Defining email notification targets

The Web interface enables you to have notifications of system alarm conditions sent by email. To use this feature, the outgoing email server must be defined in the “E-mail notifications screen”, accessible from the Configuration menu.

Figure 307: Defining email notification targets

Table 20: Fields in the email notifications screen

FIELD	DESCRIPTION
SMTP server address	DNS name or IP address of the outgoing email server. The Power+ must be defined to the email server as NOT requiring a login.
SMTP port	Predefined SMTP port for the notification messages
Send as:	The “from” address in the outgoing email. Note: some email servers have an anti-spam feature that requires the “from” address to be a valid, existing address.
Recipients	In each line under the “Recipients” header a single email address can be entered in standard format. For example: “PeterSmyth@networx.com” (without the quotes). A single email address representing a list of addresses can also be entered.

9.3.7.8 Defining SMS notifications

The “SMS notifications” option of the configuration menu enables you to define telephone numbers that are to receive notification via SMS in the event of specific alarm conditions on the Power+.

Figure 308: Defining SMS recipients

Table 21: Fields in the SMS notification target definition screen

FIELD	DESCRIPTION
Phone number	Specify the phone number to which the SMS notification will be sent. The notification includes an indication of the type of alarm.

10. SNMP AGENT

The Power+ controller includes an SNMP³ agent that enables remote monitoring and control of the Power+, and automatic orderly shutdown of any servers powered by the UPS. The SNMP agent provides connectivity between the UPS and external UPS management software such as Gamatronic's **PSM-AC Power+**.

The SNMP agent provides information on request about present operating conditions, including real-time measurements such as input and output voltages, currents, and frequencies. In the event of a power outage, the SNMP agent can perform an automatic, orderly shutdown of Windows computer systems before the UPS batteries run out. (A small shutdown client must be installed on each target computer).

The SNMP agent also provides real-time notification of UPS events in several modalities; for example, via email or SMS (with the optional WING component connected to the system controller).

The SNMP agent is intended for use with a UPS management software application such as **PSM-AC Power+**, a sophisticated software suite for managing multiple power supplies and UPS systems. **PSM-AC Power+** is compatible with Windows, Unix, Linux, and Netware servers. The systems can be controlled both locally and remotely.

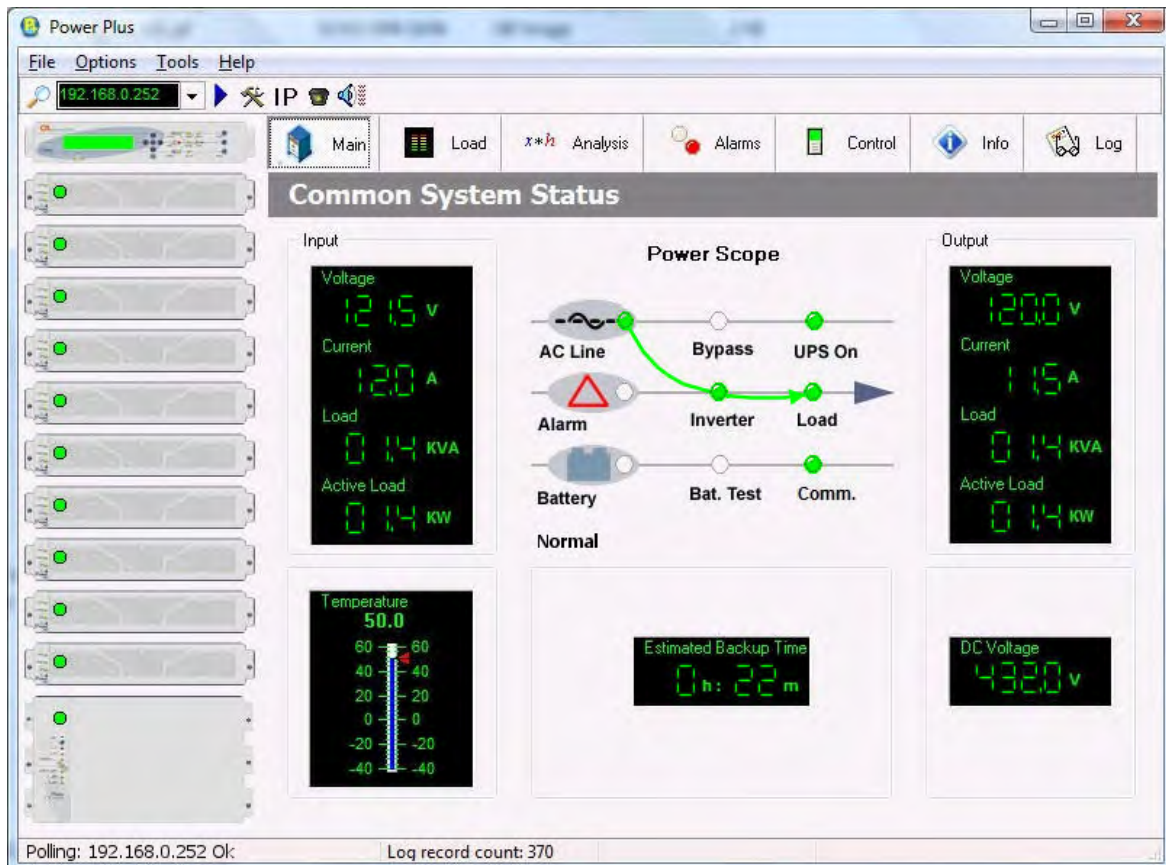

Figure 309: **POWER+ PSM-AC** lets you monitor and control your **POWER+ UPS**

³ Simple Network Management Protocol

11. WING: WIRELESS CONTROL (OPTION)

The **POWER+** system includes an option for wireless control and management, using Gamatronic's **Wing**.

The **Wing** allows real-time detection of power system faults and immediately notifies selected recipients (control center, technician, etc.) detailing the faults.

The **Wing** consists of:

- Wing board.
- SIM board.
- Antenna.
- D9-D9 cable (for RS232 between the Power+ and the Wing).
- Dc power cable (banana plugs on both ends).

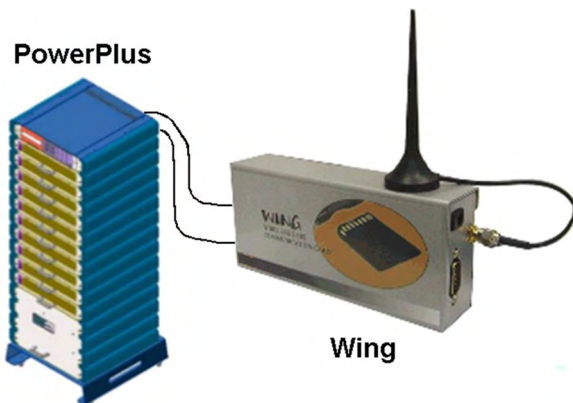

Figure 310: A Wing unit connected to the PowerPlus

11.1 Installing the Wing

Note: *The instructions in this section are for a Wing unit that has been ordered specifically for use with a Power+ system. If your Wing was ordered for use with another type of system, it does not contain the appropriate software for use with a Power+ system and you should contact your Gamatronic representative if you wish to convert it for Power+ use.*

To install a Wing unit for use with a Power+ system:

1. Take the Wing and press the button on the left side of the SIM slot to unlock the SIM cardholder; remove the SIM cardholder from the Wing.
2. Place your SIM card (which you obtained from your cellular service provider) in the SIM cardholder and slide the SIM cardholder gently and firmly back into the Wing.
3. Attach the supplied cellular antenna to the Wing.
4. Connect the Wing to the D9 socket labeled "Wing" on the left rear side of the controller using the supplied D9-D9 cable.

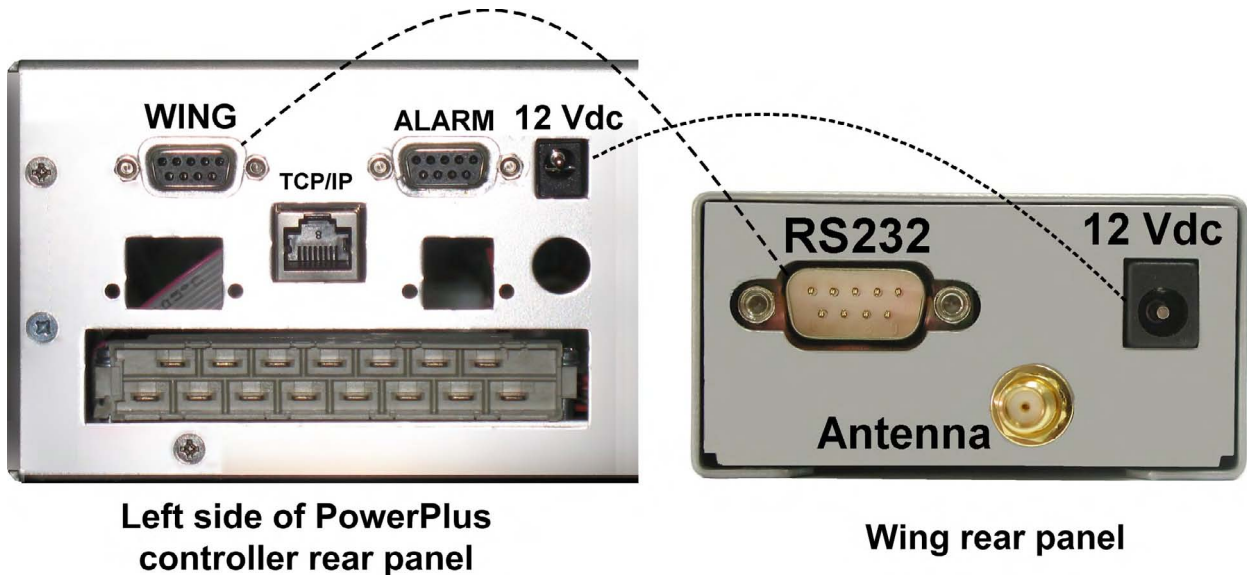

Figure 311: Connections between the Power+ controller and the Wing

5. Connect the supplied power cable between the 12 Vdc socket on the left side of the controller rear panel and the Wing.
6. On a computer that is connected to the same network as the Power+, open a web browser, type the IP address of the Power+ into the URL bar, and press Enter. The home page of the Power+ web interface is displayed.

(If you do not know the Power+'s IP address, you can see it by pressing and holding the Esc button for 2 or 3 seconds and then choosing "Network" on the displayed menu.)

Verify that an antenna symbol resembling a trident appears in the lower left corner of the browser window. This indicates that the Wing has a cellular connection.

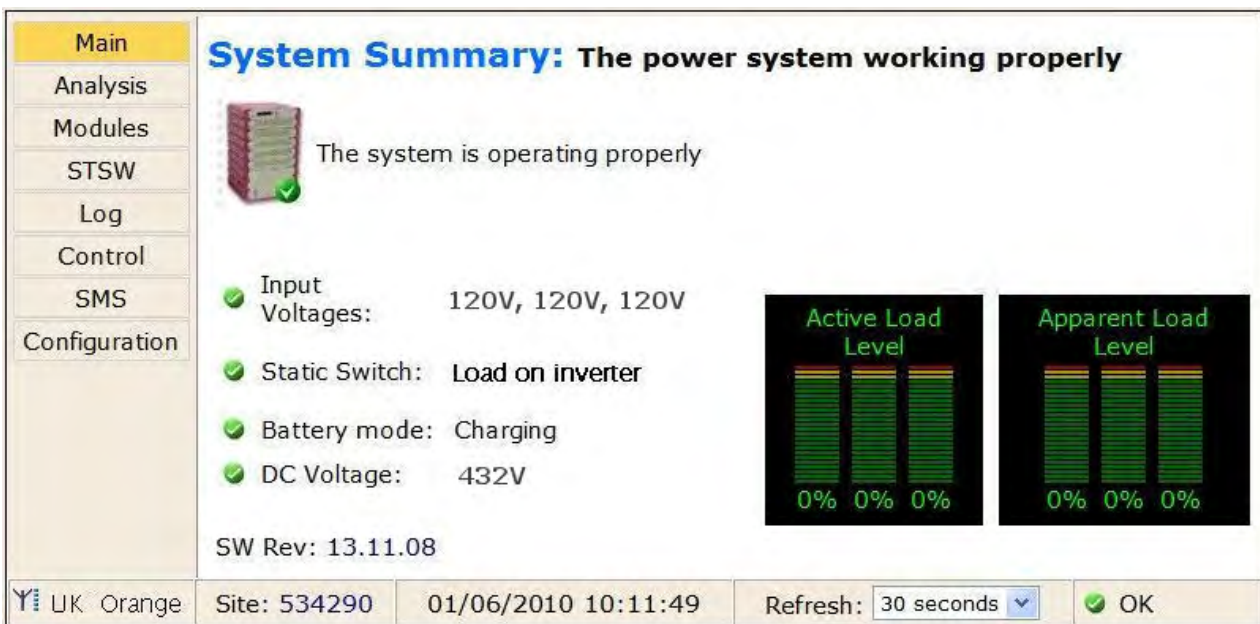

Figure 312: Home screen of the Power+ web interface

7. From the Wing home page, navigate to **Configuration > SMS notifications**.
8. Enter the telephone numbers to which you want to have alarm notifications sent.
9. Commands and queries can be sent to the Wing from any cellular telephone.

To see a log of the incoming and outgoing SMS messages, choose **SMS** in the menu column at the left side of the web page.

To see a list of the available SMS commands, on the SMS screen select the "Available SMS commands" link at the bottom of the SMS notifications screen. The available SMS commands are also listed here in continuation.



Figure 313: The SMS screen on the Power+ web interface

Table 22: List of SMS commands

Command	Description
?	Commands are: ? help alarms status target pass reboot
help	Commands are: ? help alarms status target pass reboot
alarms	Get all active alarms
status	Get the system real time values
target	USAGE: target (index) (phone) (---) (password) Example: sms 1 +7123456789 admin
pass	USAGE: pass (new password) (old password) Example: pass abcd admin
reboot	Restart the system and network controller USAGE: reboot (password) Example: reboot admin

12. RELATED PRODUCTS

12.1 G4



Figure 314: GMACi G4

The G4 adds value to your Power+:

- Option to connect external temperatures sensors.
- Input dry contacts available for on/off external sensors.
- Output dry contacts for control of external devices.
- Supports TCP/IP and SNMPv2.
- Controlled shutdown of servers on ac mains power failure, with user-defined time-delay. (*)
- Auto-wake-up of servers on restoration of ac power, after user-defined time-delay. (*),(**)
- Include internal GSM modem (quad-band) for an additional remote control and management link without LAN dependency.
- Bi-directional control via simple SMS commands.
- Automatic response to sensed events. For example, the G4 can be programmed to turn on an air conditioner when it senses that the room temperature has exceeded a user-defined level.
- Notifies designated targets of alarm conditions via email, SMS, and SNMP traps.
- Quick installation.

(*) Not all operating systems supported.

(**) Auto-wake-up requires "wake-on-LAN" BIOS feature on target computers. Not all operating systems supported.

Note: G4 requires disconnection of the Power+ internal network card. Consult Gamatronic's support team before ordering.

12.2 G-Eye



Figure 315: G-Eye

G-Eye adds value to your Power+:

- Option to connect external temperatures sensors, humidity sensors, and frequency sensors.
- Inputs for ac/dc current and voltage measurements through Gamatronic sensors.
- When the measured value moves outside a user-defined range, G-Eye immediately informs pre-selected targets of the alarm condition.
- One 4-20 mA input.
- Input dry contacts available for on/off external sensors.
- Output dry contacts for control of external devices.
- Supports TCP/IP and SNMPv2.
- Controlled shutdown of servers on ac mains power failure, with user-defined time-delay. (*)
- Auto-wake-up of servers on restoration of ac power, after user-defined time-delay. (*), (**)
- Include internal GSM modem (quad-band) for additional backup/control/management without LAN dependency.
- Bi-directional control via simple SMS commands.
- Automatic response to sensed events. For example, the G4 can be programmed to turn on an air conditioner when it senses that the room temperature has exceeded a user-defined level.
- Notifies designated targets of alarm conditions via email, SMS, and SNMP traps.
- Double power feed for reliability.
- Internal battery backup.
- Quick installation.

(*) Not all operating systems supported.

(**) Auto-wake-up requires "wake-on_LAN" BIOS feature on target computers. Not all operating systems supported.

Note: G-Eye requires disconnection of the Power+ internal network card. Consult Gamatronic's support team before ordering.

13. MAINTENANCE BYPASS MODE

In maintenance bypass mode, the UPS output terminals continue to supply power to the load, but the interior of the UPS is isolated from the main power flows. This enables a technician to work safely on the UPS (after turning off the battery circuit breaker) without any interruption of power to the load.

13.1 Putting the UPS in maintenance bypass mode

In normal operation, the UPS's ac circuit breakers are positioned as shown in Table 23.

Table 23: Normal operating position of the ac circuit breakers

RECTIFIER AC INPUT	BYPASS AC INPUT	AC OUTPUT	MAINTENANCE BYPASS
ON	ON	ON	OFF

To put the system in maintenance bypass mode:

1. Verify that the bypass indicator is lit on the Static Switch. (If it is not lit, the UPS cannot go into bypass mode.)
2. On the Controller front panel, press the INV/BYP button twice to put the UPS in bypass mode.
3. Verify that the bypass indicator is lit on the controller.

Then, operate the UPS's ac circuit breakers as follows:

4. Switch ON the MAINTENANCE BYPASS circuit breaker.
5. Switch OFF the AC OUTPUT circuit breaker.
6. Switch OFF the RECTIFIER AC INPUT circuit breaker.
7. Switch OFF the BYPASS AC INPUT circuit breaker.

The ac circuit breakers are now positioned as ac OUTPUT switch (the right-side switch).

8. Switch OFF the rectifier INPUT switch (the left-side switch).

The switches are now positioned as shown in Table 24.

Table 24: Position of the ac CBs in maint. bypass mode

RECTIFIER AC INPUT	BYPASS AC INPUT	AC OUTPUT	MAINTENANCE BYPASS
OFF	OFF	OFF	ON

9. Switch OFF the BATTERY circuit breaker on the UPS rear panel.

The system is now in maintenance bypass mode.

13.2 Returning the UPS to normal operation

To move the system from maintenance bypass mode to normal operation mode:

1. Switch ON the BATTERY circuit breaker.
2. Switch ON the RECTIFIER AC INPUT circuit breaker.
3. Switch ON the BYPASS AC INPUT circuit breaker.
4. Switch ON the UPS (refer to section 6.1, Start-up after Shutdown, on page 57).
5. Press the INV/BYP button twice to put the UPS into bypass mode.
6. Verify that the bypass indicator is lit on the controller.
7. Switch ON the AC OUTPUT circuit breaker.
8. Switch OFF the MAINTENANCE BYPASS circuit breaker.
9. On the controller front panel, press the INV/BYP button twice to put the UPS in inverter (normal) mode.
10. Verify that the green INV indicator is lit on the controller front panel.

The loads are now supplied by the UPS.

14. PREVENTIVE MAINTENANCE

Technologically advanced electronic systems are the heart of every Gamatronic UPS. These electronic systems are sensitive to environmental conditions. It is important that the operating and storage environments of the UPS be clean and dust-free, free of dampness and excess humidity.

The system's batteries provide back-up power to the UPS when needed. An environmental temperature of 20 °C (68 °F) is ideal for the batteries. Significantly higher temperatures shorten the batteries' lifespan.

The UPS and its batteries both require periodic preventive maintenance inspections. At the least, these inspections should include a visual inspection of the UPS and its batteries, and the tightening of any screws and bolts that have over time become loosened. The owner of the UPS is responsible for ensuring that the preventive maintenance inspections take place. This is done by contacting Gamatronic's service department and arranging a mutually convenient time for a technician to perform the inspection.

It is important that the UPS owner continue to arrange regular preventive maintenance inspections even after the expiration of the initial warrantee period.

Gamatronic bears no liability for damage caused to the UPS due to improper maintenance by third parties, in particular after the expiration of the warrantee or service agreement.

It is the responsibility of the UPS owner to uphold his responsibilities according to the warrantee or service agreement. This includes ensuring that the UPS's environment meets requirements.

15. SERVICE AND REPAIRS

Gamatronic maintains a team of service technicians, repair laboratories, and an ample inventory of spare parts, dedicated to the service and repair of our products. When service is required, it will be performed either at the customer's site or in one of our laboratories, according to the judgment of our technician and the specifics of the service agreement between the customer and Gamatronic.

In regards to service, oral agreements have no standing. Service shall be provided gratis during the warrantee period, on the condition that the UPS has been properly maintained and a written record has been kept of any maintenance performed on the system.

The initial warrantee period can be extended by a written service agreement between Gamatronic and the customer. Without a written agreement, Gamatronic is under no obligation to provide service after expiration of the initial warrantee period.

Gamatronic will not be responsible for maintenance or changes to the UPS that are performed by an agent without written authorization from Gamatronic.

16. TECHNICAL SPECIFICATIONS

Table 25: Technical specifications for the RM100 3x208 Vac

POWER+ TECHNICAL DATA	
Topology	True On-line Battery, Double Conversion, VFI
Construction	Modular parallel hot-plugged modules
Operation	Continuous
Input	
Voltage	3 × 208 Vac + N (3 x 120 Vac, N = Neutral)
Voltage range	+15 % and -25 %
Current	28 A per module – no inrush current at startup
Frequency	47 Hz–63 Hz
Power walk-in	> 60 sec.
Power Factor	0.99
THDI	5 %
Output	
Rated power for 3-3 configuration:	10 kVA / 8 kW to 100 kVA / 80 kW
Frequency tracking range	±2 Hz
Slew rate	1 Hz / sec.
Voltage	3 × 208 Vac + N (3 x 120 Vac, N = Neutral)
Static Regulation	±1 %
Regulation for unbalanced load	±1 % for 100% unbalanced load
Dynamic resp. to 100% load step	±2 %
Overload	110 % for 10 min., 125 % for 60 sec., 1000 % for 1 cycle
Waveform	Sinusoidal
THD	Less than 2 % for linear load
Load CF	4:1
Ac-Ac efficiency (nominal)	Up to 94 % at full load
Dc-Ac efficiency (nominal)	Up to 97 % at full load
Batteries	
Dc-Link Voltage	±160 to ±216 Vdc
Quantity (in optional external cabinet)	2 x 32 x 12 Vdc (40 Ah)
Type	Sealed, lead acid, rechargeable
General	
Maximum power dissipation (Po=8 kW)	N*510 W (N*998 BTU), where N = # modules
Ambient temperature	
operation (up to 80 kVA):	+14 to +104 °F (-10 to +40 °C)
operation (90 and 100 kVA)	+14 to +86 °F (-10 to +30 °C)
storage:	-4 to +140 °F (-20 to +60 °C)
Relative humidity	95 % max., non-condensing
Altitude	1500 m without derating
Enclosure	IP20
Cooling system	Multi-Fan with speed control (forced)
Standards	
EMC	IEC 62040-2, under EMC 2004/108/EC
Design	IEC 62040-3
Safety	IEC 62040-1, under LVD 2006/95/EC
Low magnetic field radiation	EMF as per ICNIRP

All specifications are subject to change without notice.

DIMENSIONS										
Cabinet exterior dimensions (U.S.)	H = 80 in. (42U), W = 24 in., D = 39.4 in.									
Cabinet exterior dimensions (metric)	H = 2020 mm (42U), W = 600 mm, D = 1000 mm									
UPS CAPACITY (kVA)	10	20	30	40	50	60	70	80	90	90 N+1
Weight (lbs)	424	446	469	491	514	536	559	581	604	626
Weight (kg)	192.2	202.4	212.6	222.8	233.0	243.2	253.4	263.6	273.7	284.0
Weights do not include batteries or battery cabinet.										
Acoustic Noise										
Noise (dBA) with half load	48	52	53	54	55	55.8	56.4	57	57.5	58
Noise (dBA) with full load	51	54	55	57	58	58.8	59.4	60	60.5	61

SYSTEM CONTROLLER – TECHNICAL DATA	
Microcontroller core	16 bit
Display	4 x 40 characters LCD with backlight
Other indicators	8 LEDs, buzzer
Analog input channels	3 for battery current measurement 1 for temperature measurement
Voltage-free user input channels (dry contacts)	8
Real Time Clock (RTC)	Yes (operates for 2 weeks without power)
Power meter	kVA, kW, PF
Volt-free outputs (dry contacts)	6 outputs, rated 50V/1A
RS232 user port	Yes, isolated
Optional communication	TCP/IP, GPRS/SMS wireless communications (optional)
Communications with system modules	Serial, isolated
Events log	255 events
System operation without controller	Unchanged
On-screen parameters	Load bar-graph 3-phase voltages 3-phase currents Battery voltage Status of each UPS module Static-switch parameters and status Battery sensor temperature
Alarms (floating output relay contacts, each rated for max. 48 Vdc 1 A)	Ac failure Dc failure UPS module(s) failure Load on bypass Battery test failure Over/under temperature Overload
Power requirements	3 x 208 Vac / ±216 Vdc 15 W

For a full company profile, please visit our website at www.gamatronic.com.



Gamatronic Building, Jerusalem, Israel

Gamatronic's product range:

- ▶ UPS Systems
- ▶ Power systems for Telecom
- ▶ DC-to-AC Inverters
- ▶ DC-to-DC Converters
- ▶ Frequency Changers
- ▶ Battery Chargers
- ▶ Power Management Solutions

Headquarters and Factory 14 Hartom Street, Har Hotzvim Industries Park, POB 45029,
Jerusalem 91450, Israel Tel: +972-2-588-8222 Fax: +972-2-582-8875

Gamatronic Singapore Sales Office email: singapore@gamatronic.co.il

Gamatronic (UK) Ltd. 15 Chester Road, Eaton Socon, St. Neots, Cambridgeshire PE19 8YT,
United Kingdom Tel: +44 (0)1480.479.889 Fax: +44 (0)1480.407.865 email: info@gamatronic.net